



PratiKa Industrial plugs and sockets

Catalogue 2018
Low and Extra-Low voltage



schneider-electric.com

Life Is On

Schneider
Electric

PratiKa plugs and sockets

Contents



Presentation	4
PratiKa plugs and sockets	4
General presentation	4
Low voltage and extra-low voltage	5
Sockets with interlock switch	8
Serie Unika	10
Serie Isoblock	11
Kaedra system	12

Plugs	14
PratiKa plugs	14
Low voltage	14
Selection guide	14
Wander plugs	16
Wander plugs angled 90°	17
Wall-mounted plugs	18
Wall-mounted plugs with back box	19
Panel-mounted plugs	20
System adapters	21
Plugs with phase inverter	22
Extra-low voltage	24
Selection guide	24
Wander plugs and wall-mounted plugs	25

Sockets	26
PratiKa sockets	26
Low voltage	26
Selection guide	26
Wander sockets	28
Wall-mounted sockets	29
Wall-mounted sockets with Back box	30
Back box wall-mounted for PratiKa panel and sockets	31
Panel-mounted angled and straight sockets	32
Multiple adapters	34
Domestic panel-mounted sockets	35
Extra-low voltage	36
Selection guide	36
Wander sockets	38
Panel-mounted and wall-mounted sockets	39
With interlock switch	40
Unika - Isoblock / Selection guide	40
Unika series / Panel-mounted version	42
Unika series / Wall-mounted version	43
Unika series / Panel-mounted and wall-mounted version	44
Unika series / Installation flexibility	45
Unika series / Wall and embedded-box	46
Unika series / Modular bases	47
Isoblock series / Wall-mounted version	48
Isoblock series / Modular panels	50

Plugs and sockets for containers	52
PratiKa plugs and sockets	52
Low voltage	52
Selection guide	52
Solution for container	54



Kaedra system 56

Kaedra system	56
Selection guide	56
Enclosures for sockets	57
Fitting system	58
Plaques and accessories	59

Accessories 60

Kaedra system	60
----------------------	-----------

Technical guide 62

General information	62
Degree of protection IP	64
Degree of protection IK	65
Behaviour to abnormal heat and to fire	66
Behaviour to chemical agents	67
Summary table of identification and interchangeability	68

Dimensions 70

PratiKa plugs and sockets	70
Low voltage	70
Wander plugs and sockets	70
Plugs with phase inverter - Systems adapters	71
Wall-mounted plugs	72
Panel-mounted plugs - Wall-mounted sockets	73
Wall-mounted sockets	74
Panel-mounted sockets	75
PratiKa sockets with interlock switch	78
Unika	78
Isoblock	80
Kaedra System	81
Enclosures for sockets	81
Enclosures for modular devices	82
Interface enclosures / Universal enclosures	83

General code index 84

Index	84
--------------	-----------



Additional safety is assured by sockets with electrical switch in which a mechanical lock avoid plug insertion and extraction on charge.

Sockets with interlock switch



PratiKa offer includes the FAST patented solution: this innovative cabling system enables connection without stripping the conductor and with absolutely no screws required.

Plugs and sockets

> Complete solutions:

- Quick to connect
- Safe to use
- Functional and ergonomic
- Easy and intuitive



Kaedra

Kaedra enclosures for PratiKa industrial sockets are part of a complete system of watertight enclosures from 16 to 125 A, providing solutions for protection, control and electrical distribution for tertiary and industrial applications.

PratiKa plugs and sockets

Low voltage and extra-low voltage

PR1102195



A complete range of high performance industrial plugs and sockets

The PratiKa range of industrial plugs and sockets is basically designed to suit all needs and all kinds of environments: tertiary sector, industry, building sites, workshops, agricultural sector, as well as indoor and outdoor of any kind of building.

This wide range of plugs and sockets is the result of Schneider's experience and know-how, it is a complete range, available for the 16 A, 32 A, 63 A and 125 A with degree of protection IP44 and IP67 in the wander, panel and wall versions.

These solutions are:

- fast to connect
- safe in the use
- functional and ergonomic
- easy and intuitive.

PR1102299



A complete range of products to supply circuits with risks of direct and indirect contacts with live parts

The range includes 16 and 32 A versions available in different number of pole (2P and 3P).

PratiKa with FAST connection



The **FAST** connecting system is the most innovating solution of this series which guarantees the connection without stripping the conductor, in total absence of screw.

This logo is the guarantee of the new patented connecting system of the **FAST** series.

This solution is dedicated to flexible cables both for the 16 A and 32 A.

PratiKa with SCREW connection



The **SCREW** version simplifies the most common cabling solution, having introduced the orientation of the screws which are completely open to speed the cabling.

PratiKa plugs and sockets

Low voltage and extra-low voltage

Wall plugs and sockets

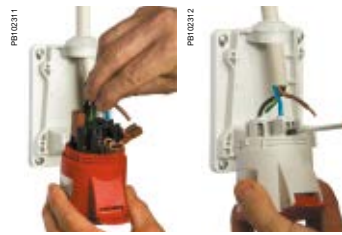

Wall installations both for plugs and sockets can now be realised with PratiKa Wall IP44 available with the FAST and the SCREW solution, 16 A and 32 A.

Robustness due to rigid cover, stainless steel screws and high level of thermoplastic material permit the use in tertiary, industry and any sector.

Complete solutions for 63 A and 125 A



The nickel-plated contacts, the stainless steel screws, and the high performing plastic materials, ensure the maximum protection even in very humid and corrosive environments.

A high performing thermoplastic material ensures the use in any aggressive environment in presence of oils and chemical agents.

Phase inverters and solutions for container

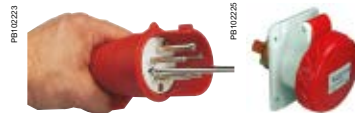

Phase inverters are designed to solve quickly and safely the problems concerning electrical connections of all rotary equipment.

These plugs and sockets have been built to ensure maximum protection and guaranteed functioning also in highly aggressive and corrosive environments.

Wander plugs angled 90°



This version allows to reduce the bulk of connection between itself and a panel sockets and limits the mechanical stresses upon the cables, due to the absence of curves.

Domestic panel sockets



A range of domestic sockets IP54 is now available presenting "shutters" (child protection) in all versions, these devices permit to avoid harmful contact with the sleeves in presence of tension.

PratiKa plugs and sockets

Low voltage and extra-low voltage

Extra-low voltage sockets



The PratiKa extra-low voltage sockets and plugs ensure the non-interchangeability by means of two reference elements:

- a guide spline
- a secondary keyway.

In accordance with the IEC 309-1 and IEC 309-2 standard.

Sockets with safety transformers



Both Unika and Isoblock series are used to power circuits with a voltage rating of 50 V maximum, in order to protect people from direct and indirect contacts, in conformity with IEC364 standards.

The units integrates the socket, the power transformer and the transformer protection from any overloading.

PratiKa plugs and sockets

Sockets with interlock switch

PR102248



A complete range in order to guarantee safety, reliability and functionality

- Unika: highly functional features and very versatile installation system.
- Isoblock: for installation in high-risk areas.

In conformity with IEC 60309 standards, all the industrial sockets have a lock or holding mechanism, which keeps the plug firmly locked in the socket, preventing it from being pulled out involuntarily.

Sockets with an interlock switch have been designed to meet the safety requirements and, in particular, to prevent plug insertion or removal while the socket is under load.

Their interlocking device allows closure of the main switch and, subsequently, the power supply only when the plug is fully inserted in the socket, and when complete mechanical and electrical connection has occurred between the sleeves and pins. Plug removal is possible only when the switch is in the "off" position.

The use of these solutions is compulsory in accordance with the regulations in force, e.g. in places where there is a risk of explosion or fire. However, in order to prevent dangerous contacts capable of causing overheating and consequently insulation deterioration or the outbreak of a fire, it is always advisable to adopt this safety measures. In this way the user has the guarantee that current can only be accessed under optimum safety conditions with the plug correctly inserted.

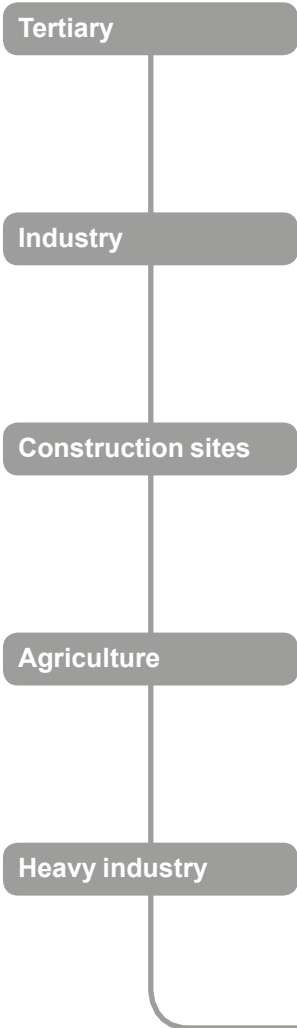

PR102249



AEC09630



PR102250



LunaPratiKa30



PR102242



D2A3-30



PR102251



D2A4-30



Domain of applications

PratiKa plugs and sockets

Sockets with interlock switch

PR102282



Global solution for industrial installations

Compact, unified sizes, versions with IP44 and IP65 protection, panel and wall-mounted, with or without integrated protection, all sockets provide quick solutions to the most demanding applications.

Unika series provides

Safety

Equipped with a mechanical switch, which ensures the control and local isolating of parts of the plant or utilities to permit intervention on electrical circuits or machines in total safety.

The sockets are in conformity with IEC 60309-2 and IEC 60309-4 standards.

Protection

Have fuse-blocks with isolators placed under the front protection and accessible only when the switch is open and plug removed and, thus, in the total absence of voltage. Thanks to the fuse clips, the contact pressure on the fuses remains constant independent of installation operations, preventing excessive overheating, harmful to their functioning and duration.

Resistance

Provides guaranteed IP44 and IP65 protection against the penetration of solids and liquids, in conformity with the IEC 60529 and EN 60529 standards, while resistance to mechanical shocks is covered by IK09 protection, in conformity with EN 62262 standards.

The structure and supporting frame of the equipment completely separated from the housing and the double walls, contribute to greatly increasing the mechanical resistance.

PR102283



A complete range for heavy-duty applications

IP65 protection, IK10 shock resistance, high resistance to aggressive chemical and atmospheric agents, specifically designed for heavy-duty applications.

Isoblock series provides

High resistance

Made of special techno-polymers, provide ultra-high resistance to aggressive chemical and atmospheric agents and guarantee maximum protection even in difficult, hazardous environments.

Protection

Against the penetration of solids and liquids, in conformity with the IEC 60529 standards, while resistance to mechanical shocks is covered by IK10 protection, in conformity with EN 62262 standards.

PratiKa plugs and sockets

Sockets with interlock switch

Serie Unika

Unique because of the following:

- one standard size 103 x 225 mm for 16 and 32 A sockets
- for IP44 and IP65 versions
- versions protected by fuses, without protection, with insulation transformers and with DIN rail for modular devices
- fitted wall-mounted, used individually, in combination or in the Kaedra system.

Compact size



Unika sockets 16 - 32 A with interlock switch come in one standard size of 103 x 225 mm, which makes them the most compact on the market, guaranteeing at the same time ultra-high performance in terms of safety and functionality.

Easy to install



Unika interlocked sockets series are very easy in installation thanks to:

- the same dimension of 16 and 32 A that can be easily interchanged on the 103 x 225 holes
- possibility to separate the body from the back box to facilitate the wall fixing and the wiring
- possibility to hang the body to comfortably cable the switch or MCBs (for 63A version)
- possibility of cable entrance from the top, from the bottom or from the side of the box.

Design



The range includes functional and optimized shapes for an standingalone installation and for perfect integration with the unique Kaedra's enclosures.

The lines, the style and the shapes where conceived also on the basis of an easy manipulation and cabling.

Kaedra System and modular bases



Unika series sockets 16 and 32 A can be installed either on single enclosures or modular bases, and can be combined to form complete, totally protected banks. Also, they can be fitted on a Kaedra system socket panels designed specifically for Unika, enabling the construction of interlocked socket panels with the possibility of differential protection integrated.

Unika 63 can be easily associated to other interlocked sockets of Unika series both vertically or horizontally, possibility available also with the Kaedra system of watertight enclosures.

PratiKa plugs and sockets

Sockets with interlock switch

Serie Isoblock

Differentiated functions



- Version with carrier for CH 10.3 x 38 cylindrical fuses in the 16 e 32 A applications and with E33 carrier for DIII fuses in the 63 A applications.
- Version with carrier for CH 10.3 x 38 cylindrical fuses equipped with LED indicator device, which it warns of the voltage presence in each phase.
- Version with DIN rail for installing any kind of modular equipment.

Modular panels



The cover of each individual interlocked socket can be easily removed enabling access for wiring and interconnections.

For the installation of associated interlocked sockets, modular panels are available ready-equipped with an junction box or modular enclosures.

Sockets with interlock switch



The Isoblock series of 63-125 A with thermal-magnetic (with or without earth-fault protection) is now equipped with the Compact NS160N circuit breaker, which give to the end-user lasting safety together with unsurpassed energy availability and very high electrical and technical features.

Socket combinations



Isoblock interlocked socket combinations consist of complete distribution units characterized by the high performance of the different sockets and, therefore, are intended for installation in hazardous environments.

They are easily combined with the connections devices supplied with each panel.

PratiKa plugs and sockets Kaedra system

050440N



The most complete range of solutions for protection, control and distribution panels for tertiary and industrial applications.

The new range of Kaedra system watertight enclosures provides solutions to all equipment installation problems, such as sockets, modular protection devices, buttons and indicator devices, etc., in environments where maximum protection is needed both for people and the electrical equipment.

The expected solution for a complete, coherent system, designed for the installation of all the Schneider Electric equipment, combining safety, functionality, ergonomics and design.

- Enclosures for sockets
- Enclosures for modular devices
- Enclosures for modular devices with interface
- Interface enclosures
- Universal enclosures

Safety

Kaedra enclosures ensure maximum protection thanks to the following:

- IP65 protection
- High resistance to shocks (IK09), chemical and atmospheric agents and UV rays
- Materials and structure designed to guarantee double insulation and access only to authorized personnel.

In conformity with the IEC 670 standards for empty boxes, and IEC 439-3 standards for complete boards.

Ergonomics

The Kaedra enclosures provide ample wiring space enabling simplified cable entry and internal distribution.

The doors and transparent flap-covers enable constant and immediate control of the operating conditions while the interface areas permit rapid access to the sockets or control devices.

The standardized concept of the opening enables quick installation of all the equipment either directly or through functional plaques.

Design

The modern and rounded shapes of the Kaedra enclosures are the result of careful studies on product design and ergonomics, and are recommended for public areas without spoiling the architectural surroundings with purely technological features.

The use of innovative colours enables them to fit in better with their surroundings while guaranteeing the principal needs of equipment visibility and control.

050440N



Enclosures for sockets

PR10275



These are available in versions for 1 to 8 sockets and include new modular opening, which enable installation of all the PratiKa series socket or integration of control and indicator devices.

Those versions are also available for installing new Unika interlocked sockets and blank versions for universal sockets.

Enclosures for modular devices

PR10256



These are available in versions for 2 to 72 modules and enable installation of all modular equipment up to 125 A, as well as combinations with equipment other than the modular type, thanks to the chassis and separate modular panels.

PratiKa plugs and sockets

Kaedra system

Enclosures for modular devices with interface



These are available in versions for 12, 24 and 36 modules and, thanks to the specific plaques, enable installation of other control, protection, and indicator device equipment on the panel front as well as domestic or industrial PratiKa sockets. These devices are accessible at any time maintaining the other modular equipment totally protected, that means without opening the door.

Interface enclosures



These are combinable with 2 or 3-unit modular enclosures and enable front installation of control, indicator devices and sockets. The internal volume provides convenient space for cable distribution within the enclosures.

Universal enclosures



These are available in 5 different sizes and enable the construction of control boards with non-modular equipment. These enclosures can be associated with all the Kaedra series enclosures enabling the construction of complete banks.

Association

The modular size of the Kaedra system enclosures enables them to be quickly associated both horizontally and vertically, allowing the board configuration to be adjusted according to the structural conditions of the installation environment. Furthermore, extensions can be made at any time by adjusting the panel according to the various needs.

Chassis

The Kaedra system enclosures, designed to accommodate modular devices, are equipped with an easily removable chassis to permit installation of equipment and wiring outside the board. This can be easily turned up side down to provide wide space for incoming and outgoing wiring. It is also possible to change the on-centre between the rails (150 mm in basic delivery version) and enabling an optimum use of the internal wiring space.

Operating details

The Kaedra enclosures have been constructed in close collaboration with the installers, enabling the integration of numerous functions designed to simplify their work. Here are some examples:

- the hinges are designed to enable enclosures to be opened without removing the cover
- the dovetail joint on the chassis and on the base permit installation of wiring collars or terminal blocks
- circuit identification labels, totally protected to ensure legibility even after numerous operations.

PratiKa plugs

Low voltage Selection guide

PratiKa plugs 16 - 32 A

Rated current	Poles and wires	Freq.	Rated voltage	Clock position of contact	Wander plugs		Wander plugs		Wander plugs angled 90°		
					FAST connect 	SCREW connect	SCREW connect	SCREW connect	SCREW connect	SCREW connect	
		Hz			IP44	IP67	IP44	IP67	IP44	IP67	
16 A	2P + \perp	50/60	100-130 V AC	4 h	PKX16M413	PKX16M713	PKE16M413	PKE16M713	-	-	
	3P + \perp	50/60		4 h	PKX16M414	PKX16M714	PKE16M414	PKE16M714	-	-	
	3P+N + \perp	50/60		4 h	PKX16M415	PKX16M715	PKE16M415	PKE16M715	-	-	
	2P + \perp	50/60	200-250 V AC	6 h	PKX16M423	PKX16M723	PKE16M423	PKE16M723	81704	81754	
	3P + \perp	50/60		9 h	PKX16M424	PKX16M724	PKE16M424	PKE16M724	-	-	
	3P+N + \perp	50/60		9 h	PKX16M425	PKX16M725	PKE16M425	PKE16M725	-	-	
	2P + \perp	50/60	380-415 V AC	9 h	PKX16M433	PKX16M733	PKE16M433	PKE16M733	-	-	
	3P + \perp	50/60		6 h	PKX16M434	PKX16M734	PKE16M434	PKE16M734	81708	81758	
	3P+N + \perp	50/60		6 h	PKX16M435	PKX16M735	PKE16M435	PKE16M735	81709	81759	
	3P + \perp	50/60	480-500 V AC	7 h	PKX16M444	PKX16M744	PKE16M444	PKE16M744	-	-	
	3P+N + \perp	50/60		7 h	PKX16M445	PKX16M745	PKE16M445	PKE16M745	-	-	
32 A	2P + \perp	50/60	100-130 V AC	4 h	PKX32M413	PKX32M713	PKE32M413	PKE32M713	-	-	
	3P + \perp	50/60		4 h	PKX32M414	PKX32M714	PKE32M414	PKE32M714	-	-	
	3P+N + \perp	50/60		4 h	PKX32M415	PKX32M715	PKE32M415	PKE32M715	-	-	
	2P + \perp	50/60	200-250 V AC	6 h	PKX32M423	PKX32M723	PKE32M423	PKE32M723	81716	81766	
	3P + \perp	50/60		9 h	PKX32M424	PKX32M724	PKE32M424	PKE32M724	-	-	
	3P+N + \perp	50/60		9 h	PKX32M425	PKX32M725	PKE32M425	PKE32M725	-	-	
	2P + \perp	50/60	380-415 V AC	9 h	PKX32M433	PKX32M733	PKE32M433	PKE32M733	-	-	
	3P + \perp	50/60		6 h	PKX32M434	PKX32M734	PKE32M434	PKE32M734	81720	81770	
	3P+N + \perp	50/60		6 h	PKX32M435	PKX32M735	PKE32M435	PKE32M735	81721	81771	
	3P + \perp	50/60	380-440 V AC	3 h	-	PKX32M7C4	-	PKE32M7C4	-	-	
	3P + \perp	50/60		480-500 V AC	7 h	PKX32M444	PKX32M744	PKE32M444	PKE32M744	-	-
	3P+N + \perp	50/60			7 h	PKX32M445	PKX32M745	PKE32M445	PKE32M745	-	-
Technical data, see page					16		16		17		

PratiKa plugs 63 - 125 A



Rated current	Poles and wires	Freq.	Rated voltage	Clock position of contact	Wander plugs	Wall-mounted plugs	Panel-mounted plugs
					SCREW connect	SCREW connect	SCREW connect
		Hz			IP67	IP67	IP67
63 A	3P + \perp	50/60	100-130 V AC	4 h	81376	81576	81876
	3P+N + \perp	50/60		4 h	81377	81577	81877
	2P + \perp	50/60		6 h	81378	81578	81878
	3P + \perp	50/60	200-250 V AC	9 h	81379	81579	81879
	3P+N + \perp	50/60		9 h	81380	81580	81880
	3P + \perp	50/60		6 h	81382	81582	81882
	3P+N + \perp	50/60	380-415 V AC	6 h	81383	81583	81883
	3P + \perp	50/60		7 h	81385	81585	81885
	3P+N + \perp	50/60		7 h	81386	81586	81886
125 A	3P + \perp	50/60	100-130 V AC	4 h	81388	81588	81888
	3P+N + \perp	50/60		4 h	81389	81589	81889
	2P + \perp	50/60		6 h	81390	81590	81890
	3P + \perp	50/60	200-250 V AC	9 h	81391	81591	81891
	3P+N + \perp	50/60		9 h	81392	81592	81892
	3P + \perp	50/60		6 h	81394	81594	81894
	3P+N + \perp	50/60	380-415 V AC	6 h	81395	81595	81895
	3P + \perp	50/60		7 h	81397	81597	81897
	3P+N + \perp	50/60		7 h	81398	81598	81898
Technical data, see page					16	19	20

Wall-mounted plugs		Wall-mounted plugs with back box		Panel-mounted plugs		Phase inverters							
FAST connect 		SCREW connect		SCREW connect		SCREW connect							
IP44		IP44		IP44		Wander-plugs		Wander plugs angled 90°		Wall-mounted plugs		Panel-mounted plugs	
IP44	IP44	IP44	IP67	IP44	IP67	IP44	IP67	IP44	IP67	IP44	IP67	IP44	IP67
PKX16W413	PKE16W413	83501	83551	81801	83851	-	-	-	-	-	-	-	-
PKX16W414	PKE16W414	83502	83552	81802	83852	-	83914	81726	81776	83526	83576	-	83876
PKX16W415	PKE16W415	83503	83553	81803	83853	83905	83915	-	81777	83527	83577	83827	83877
PKX16W423	PKE16W423	83504	83554	81804	83854	-	-	-	-	-	-	-	-
PKX16W424	PKE16W424	83505	83555	81805	83855	83901	83911	81728	81778	83528	83578	-	83878
PKX16W425	PKE16W425	83506	83556	81806	83856	83906	-	81729	81779	83529	83579	83829	83879
PKX16W433	PKE16W433	83507	83557	81807	83857	-	-	-	-	-	-	-	-
PKX16W434	PKE16W434	83508	83558	81808	83858	83902	83912	-	81780	83530	83580	83830	83880
PKX16W435	PKE16W435	83509	83559	81809	83859	83903	83913	-	-	83531	83581	83831	83881
PKX16W444	PKE16W444	83511	83561	81811	83861	-	-	81732	81782	83532	83582	83832	83882
PKX16W445	PKE16W445	83512	83562	81812	83862	-	-	81733	81783	83533	-	83833	83883
PKX32W413	PKE32W413	83513	83563	81813	83863								
PKX32W414	PKE32W414	83514	83564	81814	83864								
PKX32W415	PKE32W415	83515	83565	81815	83865								
PKX32W423	PKE32W423	83516	83566	81816	83866								
PKX32W424	PKE32W424	83517	83567	81817	83867								
PKX32W425	PKE32W425	83518	83568	81818	83868								
PKX32W433	PKE32W433	83519	83569	81819	83869								
PKX32W434	PKE32W434	83520	83570	81820	83870								
PKX32W435	PKE32W435	83521	83571	81821	83871								
-	-	-	81599	-	83899								
PKX32W444	PKE32W444	83523	83573	81823	83873								
PKX32W445	PKE32W445	83524	83574	81824	83874								
18		19		20		23							

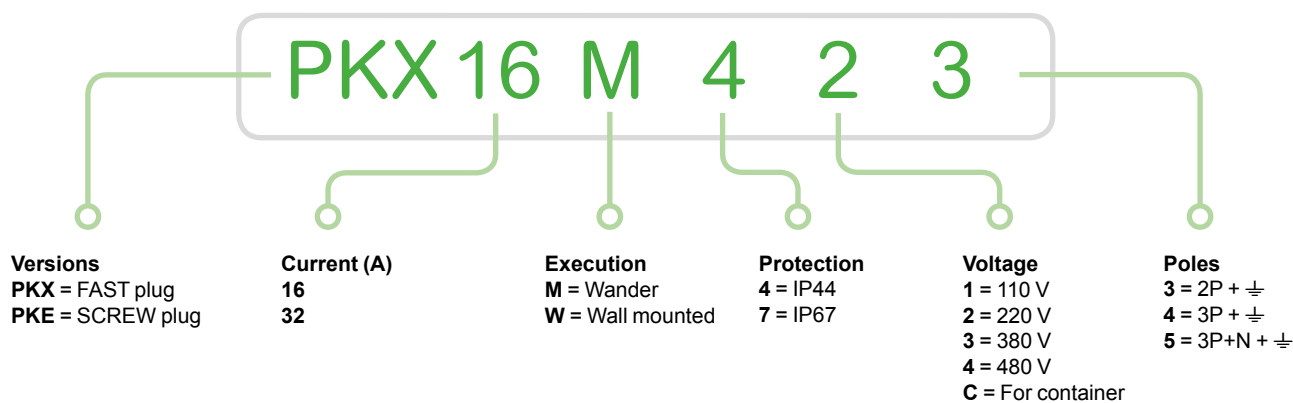
Learn how to define your PratiKa: industrial plugs



Technical data

			FAST connection, without screws	SCREW connection
				
Main characteristics			Designed to supply fixed or movable equipment by a flexible cable.	
Degree of protection	According to IEC 60529	16 and 32 A	IP44 IP67	IP44 IP67
		63 and 125 A	-	IP67
	According to EN 62262	Against external mechanical impacts	IK08	IK08
Materials			Housing made of self-extinguishing polymer Pins made of nickel-plated brass Springs and pins made of stainless steel	Housing made of self-extinguishing polymer Pins made of nickel-plated brass Springs and pins made of stainless steel
Pilot contact			-	Available in the 63 A and 125 A
Resistance to fire and abnormal heat	According to IEC 60695-2-11	Glow wire test	850°C	850°C
Connection terminals			Without screws and without stripping the conductor	Captive screws, completely loosened

Connection

Rating	FAST connection, without screws		SCREW connection		
	Cable entry	Maximum cross section of conductors	Cable entry		Maximum cross section of conductors
(In)	IP44 / IP67 Fair-lead and cable clamp	IEC 60309-1/A1, 60309-2/A1 Stranded wire cables / flexible cables	IP44 / IP67 Fair-lead and cable clamp	IP67 Cable gland	Solid cables / stranded wire cables / flexible cables
16 A	8 - 15 mm	1 to 2.5 mm ²	8 - 15 mm	-	1 to 4 mm ²
32 A	11.5 - 21 mm	2.5 to 6 mm ²	11.5 - 21 mm	-	2.5 to 10 mm ²
63 A	-	-	-	17 - 31 mm / PG36	6 to 25 mm ²
125 A	-	-	-	26 - 48 mm / PG48	16 to 70 mm ²

Code of wander plugs

Rating	Rated voltage											
	100 - 130 V AC			200 - 250 V AC			380 - 415 V AC			480 - 500 V AC		
Poles and wires	2P + \neq	3P + \neq	3P+N + \neq	2P + \neq	3P + \neq	3P+N + \neq	2P + \neq	3P + \neq	3P+N + \neq	2P + \neq	3P + \neq	3P+N + \neq

FAST connection, without screws

IP44	16 A	PKX16M413	PKX16M414	PKX16M415	PKX16M423	PKX16M424	PKX16M425	PKX16M433	PKX16M434	PKX16M435	-	PKX16M444	PKX16M445
	32 A	PKX32M413	PKX32M414	PKX32M415	PKX32M423	PKX32M424	PKX32M425	PKX32M433	PKX32M434	PKX32M435	-	PKX32M444	PKX32M445
IP67	16 A	PKX16M713	PKX16M714	PKX16M715	PKX16M723	PKX16M724	PKX16M725	PKX16M733	PKX16M734	PKX16M735	-	PKX16M744	PKX16M745
	32 A	PKX32M713	PKX32M714	PKX32M715	PKX32M723	PKX32M724	PKX32M725	PKX32M733	PKX32M734	PKX32M735	-	PKX32M744	PKX32M745

SCREW connection

IP44	16 A	PKE16M413	PKE16M414	PKE16M415	PKE16M423	PKE16M424	PKE16M425	PKE16M433	PKE16M434	PKE16M435	-	PKE16M444	PKE16M445
	32 A	PKE32M413	PKE32M414	PKE32M415	PKE32M423	PKE32M424	PKE32M425	PKE32M433	PKE32M434	PKE32M435	-	PKE32M444	PKE32M445
IP67	16 A	PKE16M713	PKE16M714	PKE16M715	PKE16M723	PKE16M724	PKE16M725	PKE16M733	PKE16M734	PKE16M735	-	PKE16M744	PKE16M745
	32 A	PKE32M713	PKE32M714	PKE32M715	PKE32M723	PKE32M724	PKE32M725	PKE32M733	PKE32M734	PKE32M735	-	PKE32M744	PKE32M745
	63 A	-	81376	81377	81378	81379	81380	-	81382	81383	-	81385	81386
	125 A	-	81388	81389	81390	81391	81392	-	81394	81395	-	81397	81398



PratiKa plugs

Low voltage
Wander plugs angled 90°

Technical data

			Angled 90°	
				
Main characteristics			They have the advantage of not being very thick.	
Degree of protection	According to IEC 60529	16 and 32 A	IP44	
	According to EN 62262	Against external mechanical impacts	IP67	
Materials			IK08	
			Housing made of self-extinguishing polymer	
			Pins made of nickel-plated brass	
Resistance to fire and abnormal heat	According to IEC 60695-2-11	Glow wire test	Stainless steel screw	
			850°C	
Connection terminals			Captive screws, completely loosened	

Connection

		Angled 90°		
Rating (In)	Cable entry	Maximum cross section of conductors		
		IP44 / IP67 Fair-lead	IP67 Cable gland	Solid cables / stranded wire cables / flexible cables
16 A	8 - 15 mm	PG16 (PG21 5P)	1 to 4 mm ²	
32 A	11.5 - 21 mm	PG21	2.5 to 10 mm ²	

Code of wander plugs angled 90°

Rating	Rated voltage											
	100 - 130 V AC			200 - 250 V AC			380 - 415 V AC			480 - 500 V AC		
Poles and wires	2P + ⚡	3P + ⚡	3P+N + ⚡	2P + ⚡	3P + ⚡	3P+N + ⚡	2P + ⚡	3P + ⚡	3P+N + ⚡	2P + ⚡	3P + ⚡	3P+N + ⚡
IP44 16 A	-	-	-	81704	-	-	-	81708	81709	-	-	-
32 A	-	-	-	81716	-	-	-	81720	81721	-	-	-
IP67 16 A	-	-	-	81754	-	-	-	81758	81759	-	-	-
32 A	-	-	-	81766	-	-	-	81770	81771	-	-	-



81704





81770

PratiKa plugs

Low voltage

Wall-mounted plugs

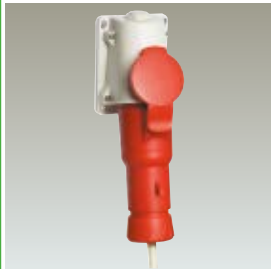
Technical data

			FAST connection, without screws	SCREW connection
				
Main characteristics			They can be installed on an appliance to enable supply by wander socket.	
Degree of protection	According to IEC 60529	16 and 32 A	IP44	IP44
	According to EN 62262	Against external mechanical impacts	IK08	IK08
Materials			Housing made of self-extinguishing polymer Pins screw made of nickel-plated brass Stainless steel	Housing made of self-extinguishing polymer Pins screw made of nickel-plated brass Stainless steel
Resistance to fire and abnormal heat	According to IEC 60695-2-11	Glow wire test	750°C	750°C
Connection terminals			Without screws and without stripping the conductor	Captive screws, completely loosened

Connection

		FAST connection, without screws			SCREW connection
Rating	Cable entry	Maximum cross section of conductors			Maximum cross section of conductors
(In)	Cable diameter	IP44 Cable entry	IEC 60309-1/A1, 60309-2/A1 Stranded wire cables / flexible cables		Solid cables / stranded wire cables / flexible cables
16 A	21.5 mm	M25 threaded nut	1 to 2.5 mm ²		1 to 4 mm ²
32 A	21.5 mm	M25 threaded nut	2.5 to 6 mm ²		2.5 to 10 mm ²

Code of wall-mounted plugs

Rating	Rated voltage											
	100 - 130 V AC			200 - 250 V AC			380 - 415 V AC			480 - 500 V AC		
Poles and wires	2P + \neq	3P + \neq	3P+N + \neq	2P + \neq	3P + \neq	3P+N + \neq	2P + \neq	3P + \neq	3P+N + \neq	2P + \neq	3P + \neq	3P+N + \neq
FAST connection, without screws												
IP44 16 A	PKX16W413	PKX16W414	PKX16W415	PKX16W423	PKX16W424	PKX16W425	PKX16W433	PKX16W434	PKX16W435	-	PKX16W444	PKX16W445
32 A	PKX32W413	PKX32W414	PKX32W415	PKX32W423	PKX32W424	PKX32W425	PKX32W433	PKX32W434	PKX32W435	-	PKX32W444	PKX32W445
SCREW connection												
IP44 16 A	PKE16W413	PKE16W414	PKE16W415	PKE16W423	PKE16W424	PKE16W425	PKE16W433	PKE16W434	PKE16W435	-	PKE16W444	PKE16W445
32 A	PKE32W413	PKE32W414	PKE32W415	PKE32W423	PKE32W424	PKE32W425	PKE32W433	PKE32W434	PKE32W435	-	PKE32W444	PKE32W445



PKX16W435

PKE16W435

PratiKa plugs

Low voltage

Wall-mounted plugs with back box

Technical data

			SCREW connection
			
Main characteristics			They can be installed on an appliance to enable supply by wander socket.
Degree of protection	According to IEC 60529	16 and 32 A	IP44
		63 and 125 A	IP67
	According to EN 62262	Against external mechanical impacts	IK08
Materials			Housing made of self-extinguishing polymer Pins made of nickel-plated brass Stainless steel screws
Pilot contact			Available in the 63 A and 125 A
Resistance to fire and abnormal heat	According to IEC 60695-2-11	Glow wire test	850°C
Connection terminals			Captive screws, completely loosened

Connection

		SCREW connection		
Rating		Cable entry		Maximum cross section of conductors
(In)		IP44 Fair-lead	IP67 Cable gland	Solid and stranded wire flexible cables
16 A		8 - 15 mm	PG16 (PG21 5P)	1 to 4 mm ²
32 A		11.5 - 21 mm	PG21	2.5 to 10 mm ²
63 A		-	PG36	6 to 25 mm ²
125 A		-	PG48	16 to 70 mm ²

Code of wall-mounted plugs

Rating	Rated voltage												
	100 - 130 V AC			200 - 250 V AC			380 - 415 V AC			480 - 500 V AC			
Poles and wires	2P + ⚡	3P + ⚡	3P+N + ⚡	2P + ⚡	3P + ⚡	3P+N + ⚡	2P + ⚡	3P + ⚡	3P+N + ⚡	2P + ⚡	3P + ⚡	3P+N + ⚡	
SCREW connection													
IP44	16 A	83501	83502	83503	83504	83505	83506	83507	83508	83509	-	83511	83512
	32 A	83513	83514	83515	83516	83517	83518	83519	83520	83521	-	83523	83524
IP67	16 A	83551	83552	83553	83554	83555	83556	83557	83558	83559	-	83561	83562
	32 A	83563	83564	83565	83566	83567	83568	83569	83570	83571	-	83573	83574
	63 A	-	81576	81577	81578	81579	81580	-	81582	81583	-	81585	81586
	125 A	-	81588	81589	81590	81591	81592	-	81594	81595	-	81597	81598

PG48101



83504

PG48106





83571

PratiKa plugs

Low voltage

Panel-mounted plugs

Technical data

			Straight SCREW connection	Angled SCREW connection
				
Main characteristics			They can be installed on an appliance to enable supply by wander socket.	
Degree of protection	According to IEC 60529	16 and 32 A	-	IP44
		63 and 125 A	IP67	IP67
Materials	According to EN 62262	Against external mechanical impacts	IK08	IK08
		Housing made of self-extinguishing polymer	Housing made of self-extinguishing polymer	
		Pins made of nickel-plated brass	Pins made of nickel-plated brass	
		-	Stainless steel screws	
Pilot contact		Available in the 63 A and 125 A	-	
Resistance to fire and abnormal heat	According to IEC 60695-2-11	Glow wire test	850°C	850°C
Connection terminals		-	-	Captive screws, completely loosened
Flange dimensions	16 A	2P + \perp	-	65 x 85 mm
		3P + \perp	-	
		3P+N + \perp	-	
	32 A	2P + \perp	-	90 x 100 mm
		3P + \perp	-	
		3P+N + \perp	-	

Connection

			Straight SCREW connection	Angled SCREW connection
Rating			Maximum cross section of conductors	
(In)			Solid and stranded wire flexible cables	
16 A	-	-	-	1 to 4 mm ²
32 A	-	-	-	2.5 to 10 mm ²
63 A	-	-	6 to 25 mm ²	-
125 A	-	-	16 to 70 mm ²	-

Note: for a correct use of the IP67-63 A, a minimum clearance of 105 mm is required for the movement of hinged cover (see details at "Retaining means for IP67 panel mounted plugs" on the dimensions page).

Code of panel-mounted plugs

Rating	Rated voltage											
	100 - 130 V AC			200 - 250 V AC			380 - 415 V AC			480 - 500 V AC		
Poles and wires	2P + \perp	3P + \perp	3P+N + \perp	2P + \perp	3P + \perp	3P+N + \perp	2P + \perp	3P + \perp	3P+N + \perp	2P + \perp	3P + \perp	3P+N + \perp
Straight SCREW connection												
IP67 63 A	-	81876	81877	81878	81879	81880	-	81882	81883	-	81885	81886
125 A	-	81888	81889	81890	81891	81892	-	81894	81895	-	81897	81898
Angled SCREW connection												
IP44 16 A	81801	81802	81803	81804	81805	81806	81807	81808	81809	-	81811	81812
32 A	81813	81814	81815	81816	81817	81818	81819	81820	81821	-	81823	81824
IP67 16 A	83851	83852	83853	83854	83855	83856	83857	83858	83859	-	83861	83862
32 A	83863	83864	83865	83866	83867	83868	83869	83870	83871	-	83873	83874

Caps to cover plugs with IP44 and IP67

Rating	Code		
Poles and wires	2P + \perp	3P + \perp	3P+N + \perp
IP67 16 A	83933	93934	83935
32 A	83936	83936	83937

PG149061



81885

PG149075



81895

PG149075



81804

PG149075



83871

PG149075



83934

Technical data

		System adapters
		
Main characteristics		<p>They enable the conversion of an industrial plug system into a domestic one. They can be used for temporary situations only and in certain industrial environments where there is no danger of explosions or fire.</p>
Conceived in conformity with standards		EN 50250 IEC 60309-1, IEC 60309-2 and IEC 60309-4
Degree of protection	According to IEC 60529	IP20
	According to EN 62262 Against external mechanical impacts	IK08
Materials		Housing made of self-extinguishing polymer Pins made of nickel-plated brass Stainless steel screws
Resistance to fire and abnormal heat	According to IEC 60695-2-11 Glow wire test	850°C

Code of System Adapters

Rating	Rated voltage			
	200 - 250 V AC			
Industrial plug side - Current and Poles	2P + \neq			
16 A	PKZA201	PKZA202	PKZA203	PKZA204
Socket side - Number and type	1 socket - 10/16 A	2 sockets - 10/16 A	1 socket - 16 A	1 socket - 10/16 A
Standard	Italy		Germany	France

Note: the English, Swiss and Italian (dual - use) Standards are available on demand.



PKZA201



PKZA202



PKZA203



PKZA204

PratiKa plugs

Low voltage

Plugs with phase inverter

The PratiKa plugs with phase inverters provide a safe, rapid solution to electrical connection problems in all rotary machines.

In fact, they permit a rapid inversion of the positions of the two pins and the phase order and, subsequently, the machine rotation direction, without having to open the plug and act on the connections.

This is achieved by simply pressing with a screwdriver on the specific area with a 180° rotation of the contact-gate block clockwise or counter-clockwise, until total inversion of the phases is obtained.

Solution for rapid inversion of electric motor rotation

The range includes different models:

- wander plugs,
- wander plugs angled 90°,
- wall-mounting plugs,
- panel-mounting plugs.

Technical data

		SCREW connection
Main characteristics		
Degree of protection	According to IEC 60529	IP44 IP67
Materials		Housing made of self-extinguishing polymer Pins made of nickel-plated brass Stainless steel screws
Resistance to fire and abnormal heat	According to IEC 60695-2-11	Glow wire test 850°C
Operating frequency		50/60 Hz
Connection terminals		Captive screws, completely loosened

Connection

		SCREW connection	
Rating		Cable entry	Maximum cross section of conductors
(In)		IP44 / IP67 Fair-lead	IP67 Cable gland
16 A		8 - 15 mm	PG16 (PG21 5P)
			Solid and stranded wire flexible cables
			1 to 4 mm ²

PratiKa plugs

Low voltage
Plugs with phase inverter



83902



83912

Code of wander plugs with phase inverter

Rating	Rated voltage							
	100 - 130 V AC		200 - 250 V AC		380 - 415 V AC		480 - 500 V AC	
Poles and wires	3P + \perp	3P+N + \perp	3P + \perp	3P+N + \perp	3P + \perp	3P+N + \perp	3P + \perp	3P+N + \perp
IP44 16 A	-	83905	83901	83906	83902	83903	-	-
IP67 16 A	83914	83915	83911	-	83912	83913	-	-



81780

Code of wander plugs angled 90° with phase inverter

Rating	Rated voltage							
	100 - 130 V AC		200 - 250 V AC		380 - 415 V AC		480 - 500 V AC	
Poles and wires	3P + \perp	3P+N + \perp	3P + \perp	3P+N + \perp	3P + \perp	3P+N + \perp	3P + \perp	3P+N + \perp
IP44 16 A	81726	-	81728	81729	-	-	81732	81733
IP67 16 A	81776	81777	81778	81779	81780	-	81782	81783



83581

Code of wall-mounted plugs with phase inverter

Rating	Rated voltage							
	100 - 130 V AC		200 - 250 V AC		380 - 415 V AC		480 - 500 V AC	
Poles and wires	3P + \perp	3P+N + \perp	3P + \perp	3P+N + \perp	3P + \perp	3P+N + \perp	3P + \perp	3P+N + \perp
IP44 16 A	83526	83527	83528	83529	83530	83531	83532	83533
IP67 16 A	83576	83577	83578	83579	83580	83581	83582	-



83880

Code of panel-mounted plugs with phase inverter

Rating	Rated voltage							
	100 - 130 V AC		200 - 250 V AC		380 - 415 V AC		480 - 500 V AC	
Poles and wires	3P + \perp	3P+N + \perp	3P + \perp	3P+N + \perp	3P + \perp	3P+N + \perp	3P + \perp	3P+N + \perp
IP44 16 A	-	83827	-	83829	83830	83831	83832	83833
IP67 16 A	83876	83877	83878	83879	83880	83881	83882	83883



83934

Caps to cover plugs with IP44 and IP67

Rating	Code	
Poles and wires	3P + \perp	3P+N + \perp
IP67 16 A	83934	83935

PratiKa plugs

Extra-low voltage

Selection guide

PratiKa plugs 16 - 32 A





Rated current	Poles and wires	Freq. Hz	Rated voltage	Clock position of secondary keyway	Wander plugs		Wall-mounted plugs
					IP44	IP67	IP44
16 A	2P	50/60	20-25 V AC	s.r.	82301	82351	82501
	3P	50/60	20-25 V AC	s.r.	82302	82352	82502
	2P	50/60	40-50 V AC	12 h	82303	82353	82503
	3P	50/60	40-50 V AC	12 h	82304	82354	82504
	2P	100/200	20-25 V AC / 40-50 V AC	4 h	82305	82355	82505
	3P	100/200	20-25 V AC / 40-50 V AC	4 h	82306	82356	82506
	2P	401/500	20-25 V AC / 40-50 V AC	11 h	82311	82361	82511
	3P	401/500	20-25 V AC / 40-50 V AC	11 h	82312	82362	82512
32 A	2P	---	20-25 V AC / 40-50 V AC	10 h	82313	82363	82513
	2P	50/60	20-25 V AC	s.r.	82315	82365	82515
	3P	50/60	20-25 V AC	s.r.	82316	82366	82516
	2P	50/60	40-50 V AC	12 h	82317	82367	82517
	3P	50/60	40-50 V AC	12 h	82318	82368	82518
	2P	100/200	20-25 V AC / 40-50 V AC	4 h	82319	82369	82519
	3P	100/200	20-25 V AC / 40-50 V AC	4 h	82320	82370	82520
	2P	401/500	20-25 V AC / 40-50 V AC	11 h	82325	82375	82525
3P	401/500	20-25 V AC / 40-50 V AC	11 h	82326	82376	82526	
2P	---	20-25 V AC / 40-50 V AC	10 h	82327	82377	82527	
Technical data, see page					25		

PratiKa plugs

Extra-low voltage

Wander plugs and wall-mounted plugs

Technical data

			Wander plugs	Wall-mounted plugs
				
Main characteristics			Installations and wander sockets can be powered by a flexible cable.	They can be wall-mounted to supply appliances with wander plugs.
Degree of protection	According to IEC 60529	16 and 32 A	IP44	IP44
	According to EN 62262	Against external mechanical impacts	IP67	IP67
Materials			Housing made of self-extinguishing polymer	Housing made of self-extinguishing polymer
			Pins made of nickel-plated brass	Pins made of nickel-plated brass
			Stainless steel screw	Stainless steel screw
Resistance to fire and abnormal heat	According to IEC 60695-2-11	Glow wire test	850°C	850°C
Connection terminals			Captive screws, completely loosened	Captive screws, completely loosened

Connection

Wander plugs and wall-mounted plugs			
Rating	Cable entry		Maximum cross section of conductors
(In)	IP44 / IP67 Fair-lead	IP67 Cable gland	Solid and stranded wire flexible cables
16 A	6 - 23 mm	PG21	4 to 10 mm ²
32 A	6 - 23 mm	PG21	4 to 10 mm ²

Code of wander plugs

Rating	Rated voltage											
	20-25 V 50/60 Hz		40-50 V 50/60 Hz		20-25 V / 40-50 V 100-200 Hz				401-500 Hz		20-25 V / 40-50 V ---	
Poles and wires	2P	3P	2P	3P	2P	3P	2P	3P	2P	3P	2P	3P
IP44 16 A	82301	82302	82303	82304	82305	82306	82311	82312	82313	-	-	-
	32 A	82315	82316	82317	82318	82319	82320	82325	82326	82327	-	-
IP67 16 A	82351	82352	82353	82354	82355	82356	82361	82362	82363	-	-	-
	32 A	82365	82366	82367	82368	82369	82370	82375	82376	82377	-	-

Code of wall-mounted plugs

Rating	Rated voltage											
	20-25 V 50/60 Hz		40-50 V 50/60 Hz		20-25 V / 40-50 V 100-200 Hz				401-500 Hz		20-25 V / 40-50 V ---	
Poles and wires	2P	3P	2P	3P	2P	3P	2P	3P	2P	3P	2P	3P
IP44 16 A	82501	82502	82503	82504	82505	82506	82511	82512	82513	-	-	-
	32 A	82515	82516	82517	82518	82519	82520	82525	82526	82527	-	-



82301



82368



82501

PratiKa sockets

Low voltage Selection guide

PratiKa sockets 16 - 32 A

Rated current	Poles and wires	Freq. Hz	Rated voltage	Clock position of contact	Wander sockets		Panel mounted sockets				
					FAST connect		Angled FAST connect		Straight FAST connect		
					IP44	IP67	IP44	IP67	IP44	IP67	
16 A	2P + \perp	50/60	100-130 V AC	4 h	PKY16M413	PKY16M713	PKY16F413	PKY16F713	PKY16G413	PKY16G713	
	3P + \perp	50/60		4 h	PKY16M414	PKY16M714	PKY16F414	PKY16F714	PKY16G414	PKY16G714	
	3P+N + \perp	50/60		4 h	PKY16M415	PKY16M715	PKY16F415	PKY16F715	PKY16G415	PKY16G715	
	2P + \perp	50/60	200-250 V AC	6 h	PKY16M423	PKY16M723	PKY16F423	PKY16F723	PKY16G423	PKY16G723	
	3P + \perp	50/60		9 h	PKY16M424	PKY16M724	PKY16F424	PKY16F724	PKY16G424	PKY16G724	
	3P+N + \perp	50/60		9 h	PKY16M425	PKY16M725	PKY16F425	PKY16F725	PKY16G425	PKY16G725	
	2P + \perp	50/60	380-415 V AC	9 h	PKY16M433	PKY16M733	PKY16F433	PKY16F733	PKY16G433	PKY16G733	
	3P + \perp	50/60		6 h	PKY16M434	PKY16M734	PKY16F434	PKY16F734	PKY16G434	PKY16G734	
	3P+N + \perp	50/60		6 h	PKY16M435	PKY16M735	PKY16F435	PKY16F735	PKY16G435	PKY16G735	
	3P + \perp	50/60	480-500 V AC	7 h	PKY16M444	PKY16M744	PKY16F444	PKY16F744	PKY16G444	PKY16G744	
	3P+N + \perp	50/60		7 h	PKY16M445	PKY16M745	PKY16F445	PKY16F745	PKY16G445	PKY16G745	
	3P + \perp	50/60		4 h	PKY32M413	PKY32M713	PKY32F413	PKY32F713	PKY32G413	PKY32G713	
	32 A	3P + \perp	50/60	100-130 V AC	4 h	PKY32M414	PKY32M714	PKY32F414	PKY32F714	PKY32G414	PKY32G714
		3P+N + \perp	50/60		4 h	PKY32M415	PKY32M715	PKY32F415	PKY32F715	PKY32G415	PKY32G715
2P + \perp		50/60	200-250 V AC		6 h	PKY32M423	PKY32M723	PKY32F423	PKY32F723	PKY32G423	PKY32G723
3P + \perp		50/60		9 h	PKY32M424	PKY32M724	PKY32F424	PKY32F724	PKY32G424	PKY32G724	
3P+N + \perp		50/60		9 h	PKY32M425	PKY32M725	PKY32F425	PKY32F725	PKY32G425	PKY32G725	
2P + \perp		50/60	380-415 V AC	9 h	PKY32M433	PKY32M733	PKY32F433	PKY32F733	PKY32G433	PKY32G733	
3P + \perp		50/60		6 h	PKY32M434	PKY32M734	PKY32F434	PKY32F734	PKY32G434	PKY32G734	
3P+N + \perp		50/60		6 h	PKY32M435	PKY32M735	PKY32F435	PKY32F735	PKY32G435	PKY32G735	
3P + \perp		50/60	380-440 V AC	3 h	-	PKY32M7C4	-	PKY32F7C4	-	PKY32G7C4	
3P + \perp		50/60		7 h	PKY32M444	PKY32M744	PKY32F444	PKY32F744	PKY32G444	PKY32G744	
3P+N + \perp		50/60		7 h	PKY32M445	PKY32M745	PKY32F445	PKY32F745	PKY32G445	PKY32G745	

Technical data, see page

28

32

PratiKa sockets 63 - 125 A

Rated current	Poles and wires	Freq. Hz	Rated voltage	Clock position of contact	Wander sockets		Wall-mounted sockets			
					SCREW connect		Angled SCREW connect		Straight SCREW connect	With back box SCREW connect
					IP67	IP67	IP67	IP67	IP67	
63 A	3P + \perp	50/60	100-130 V AC	4 h	81476	81276	81676	81176		
	3P+N + \perp	50/60		4 h	81477	81277	81677	81177		
	2P + \perp	50/60	200-250 V AC	6 h	81478	81278	81678	81178		
	3P + \perp	50/60		9 h	81479	81279	81679	81179		
	3P+N + \perp	50/60		9 h	81480	81280	81680	81180		
	3P + \perp	50/60	380-415 V AC	6 h	81482	81282	81682	81182		
	3P+N + \perp	50/60		6 h	81483	81283	81683	81183		
	3P + \perp	50/60		7 h	81485	81285	81685	81185		
	3P+N + \perp	50/60	480-500 V AC	7 h	81486	81286	81686	81186		
	3P + \perp	50/60		4 h	81488	81288	81688	81188		
3P+N + \perp	50/60	4 h		81489	81289	81689	81189			
125 A	2P + \perp	50/60	200-250 V AC	6 h	81490	81290	81690	81190		
	3P + \perp	50/60		9 h	81491	81291	81691	81191		
	3P+N + \perp	50/60	380-415 V AC	9 h	81492	81292	81692	81192		
	3P + \perp	50/60		6 h	81494	81294	81694	81194		
	3P+N + \perp	50/60		6 h	81495	81295	81695	81195		
	3P + \perp	50/60	480-500 V AC	7 h	81497	81297	81697	81197		
	3P+N + \perp	50/60		7 h	81498	81298	81698	81198		

Technical data, see page

28

29

33

30

Wander sockets		Panel mounted sockets				Wall-mounted sockets					
SCREW connect		Angled SCREW connect		Straight SCREW connect		FAST connect		SCREW connect		With back box SCREW connect	
IP44	IP67	IP44	IP67	IP44	IP67	IP44	IP44	IP67	IP44	IP67	
PKF16M413	PKF16M713	PKF16F413	PKF16F713	PKF16G413	PKF16G713	PKY16W413	PKF16W413	PKF16W713	83101	83151	
PKF16M414	PKF16M714	PKF16F414	PKF16F714	PKF16G414	PKF16G714	PKY16W414	PKF16W414	PKF16W714	83102	83152	
PKF16M415	PKF16M715	PKF16F415	PKF16F715	PKF16G415	PKF16G715	PKY16W415	PKF16W415	PKF16W715	83103	83153	
PKF16M423	PKF16M723	PKF16F423	PKF16F723	PKF16G423	PKF16G723	PKY16W423	PKF16W423	PKF16W723	83104	83154	
PKF16M424	PKF16M724	PKF16F424	PKF16F724	PKF16G424	PKF16G724	PKY16W424	PKF16W424	PKF16W724	83105	83155	
PKF16M425	PKF16M725	PKF16F425	PKF16F725	PKF16G425	PKF16G725	PKY16W425	PKF16W425	PKF16W725	83106	83156	
PKF16M433	PKF16M733	PKF16F433	PKF16F733	PKF16G433	PKF16G733	PKY16W433	PKF16W433	PKF16W733	83107	83157	
PKF16M434	PKF16M734	PKF16F434	PKF16F734	PKF16G434	PKF16G734	PKY16W434	PKF16W434	PKF16W734	83108	83158	
PKF16M435	PKF16M735	PKF16F435	PKF16F735	PKF16G435	PKF16G735	PKY16W435	PKF16W435	PKF16W735	83109	83159	
PKF16M444	PKF16M744	PKF16F444	PKF16F744	PKF16G444	PKF16G744	PKY16W444	PKF16W444	PKF16W744	83111	83161	
PKF16M445	PKF16M745	PKF16F445	PKF16F745	PKF16G445	PKF16G745	PKY16W445	PKF16W445	PKF16W745	83112	83162	
PKF32M413	PKF32M713	PKF32F413	PKF32F713	PKF32G413	PKF32G713	PKY32W413	PKF32W413	PKF32W713	83113	83163	
PKF32M414	PKF32M714	PKF32F414	PKF32F714	PKF32G414	PKF32G714	PKY32W414	PKF32W414	PKF32W714	83114	83164	
PKF32M415	PKF32M715	PKF32F415	PKF32F715	PKF32G415	PKF32G715	PKY32W415	PKF32W415	PKF32W715	83115	83165	
PKF32M423	PKF32M723	PKF32F423	PKF32F723	PKF32G423	PKF32G723	PKY32W423	PKF32W423	PKF32W723	83116	83166	
PKF32M424	PKF32M724	PKF32F424	PKF32F724	PKF32G424	PKF32G724	PKY32W424	PKF32W424	PKF32W724	83117	83167	
PKF32M425	PKF32M725	PKF32F425	PKF32F725	PKF32G425	PKF32G725	PKY32W425	PKF32W425	PKF32W725	83118	83168	
PKF32M433	PKF32M733	PKF32F433	PKF32F733	PKF32G433	PKF32G733	PKY32W433	PKF32W433	PKF32W733	83119	83169	
PKF32M434	PKF32M734	PKF32F434	PKF32F734	PKF32G434	PKF32G734	PKY32W434	PKF32W434	PKF32W734	83120	83170	
PKF32M435	PKF32M735	PKF32F435	PKF32F735	PKF32G435	PKF32G735	PKY32W435	PKF32W435	PKF32W735	83121	83171	
-	PKF32M7C4	-	PKF32F7C4	-	PKF32G7C4	-	-	PKF32W7C4	-	81199	
PKF32M444	PKF32M744	PKF32F444	PKF32F744	PKF32G444	PKF32G744	PKY32W444	PKF32W444	PKF32W744	83123	83173	
PKF32M445	PKF32M745	PKF32F445	PKF32F745	PKF32G445	PKF32G745	PKY32W445	PKF32W445	PKF32W745	83124	83174	
28		33				29			30		



PratiKa sockets 10 - 16 A

Rated current	Poles and wires	Freq.	Rated voltage	Type	Domestic sockets 50 x 50			Domestic sockets 65 x 85			
					Code grey IP54	Code blue IP54	Code black IP54	Code grey IP54	Code blue IP54	Code black IP54	
10 - 16 A	2P + \pm	Hz	200-250 V AC	Standard							
		50/60		Italy	-	-	-	-	81139	-	-
				French	-	-	-	-	81146	-	-
				Germany	PKN51G	PKN51B	PKN51N	PKN61G	81140	PKN61B	PKN61N
					PKN52G	PKN52B	PKN52N	PKN62G	-	PKN62B	PKN62N
				England	PKS51G	PKS51B	PKS51N	PKS61G	81141	PKS61B	PKS61N
				Switzerland	PKS52G	PKS52B	PKS52N	PKS62G	-	PKS62B	PKS62N
					-	-	-	-	81144	-	-
					-	-	-	-	81145	-	-
Description											
Support with 1 adapter RJ45 Infra+ (50/60 Hz)					-	-	-	-	81142	-	-
Support with 2 adapters RJ45 Infra+ (50/60 Hz)					-	-	-	-	81143	-	-
Technical data, see page					35						

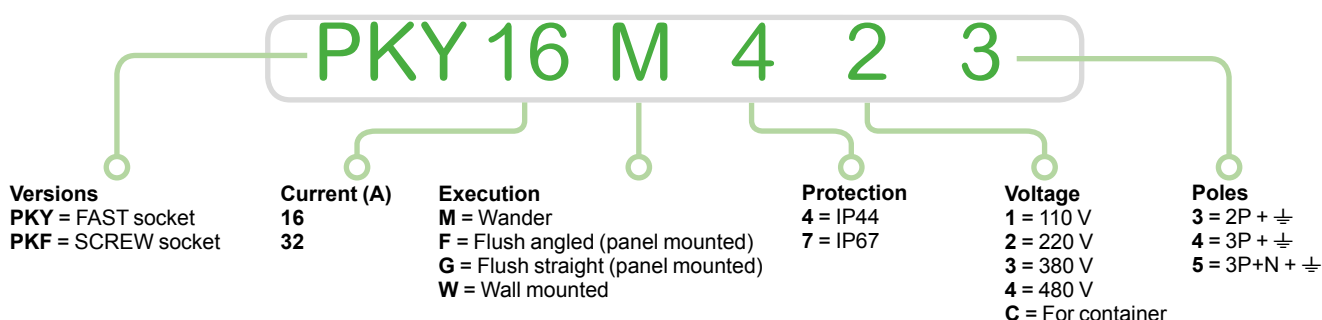
Learn how to define your PratiKa : industrial sockets



Technical data

			FAST connection, without screws	SCREW connection
				
Main characteristics			Designed to supply fixed or movable equipment by a flexible cable.	
Degree of protection	According to IEC 60529	16 and 32 A	IP44 IP67	IP44 IP67
		63 and 125 A	-	IP67
	According to EN 62262	Against external mechanical impacts	IK08	IK08
Materials			Housing made of self-extinguishing polymer Sleeves made of brass	Housing made of self-extinguishing polymer ■ Sleeves made of brass for PratiKa series ■ Sleeves made of nickel-plated brass for PratiKa series
Pilot contact			Springs and pins made of stainless steel	Springs and pins made of stainless steel
Resistance to fire and abnormal heat	According to IEC 60695-2-11	Glow wire test	- 850°C	- 850°C
Connection terminals			Without screws and without stripping the conductor	Captive screws, completely loosened

Connection



	FAST connection, without screws		SCREW connection		
Rating	Cable entry	Maximum cross section of conductors	Cable entry		Maximum cross section of conductors
(In)	IP44 / IP67 Fair-lead and cable clamp	IEC 60309-1/A1, 60309-2/A1 Stranded wire cables / flexible cables	IP44 / IP67 Fair-lead and cable clamp	IP67 Cable gland	Solid cables / stranded wire cables / flexible cables
16 A	8 - 15 mm	1 to 2.5 mm ²	8 - 15 mm	-	1 to 4 mm ²
32 A	11.5 - 21 mm	2.5 to 6 mm ²	11.5 - 21 mm	-	2.5 to 10 mm ²
63 A	-	-	-	17 - 31 mm / PG36	6 to 25 mm ²
125 A	-	-	-	26 - 48 mm / PG48	16 to 70 mm ²

Code of wander sockets

Rating	Rated voltage											
	100 - 130 V AC			200 - 250 V AC			380 - 415 V AC			480 - 500 V AC		
Poles and wires	2P + ⚡	3P + ⚡	3P+N + ⚡	2P + ⚡	3P + ⚡	3P+N + ⚡	2P + ⚡	3P + ⚡	3P+N + ⚡	2P + ⚡	3P + ⚡	3P+N + ⚡
FAST connection, without screws												
IP44 16 A	PKY16M413	PKY16M414	PKY16M415	PKY16M423	PKY16M424	PKY16M425	PKY16M433	PKY16M434	PKY16M435	-	PKY16M444	PKY16M445
32 A	PKY32M413	PKY32M414	PKY32M415	PKY32M423	PKY32M424	PKY32M425	PKY32M433	PKY32M434	PKY32M435	-	PKY32M444	PKY32M445
IP67 16 A	PKY16M713	PKY16M714	PKY16M715	PKY16M723	PKY16M724	PKY16M725	PKY16M733	PKY16M734	PKY16M735	-	PKY16M744	PKY16M745
32 A	PKY32M713	PKY32M714	PKY32M715	PKY32M723	PKY32M724	PKY32M725	PKY32M733	PKY32M734	PKY32M735	-	PKY32M744	PKY32M745
SCREW connection												
IP44 16 A	PKF16M413	PKF16M414	PKF16M415	PKF16M423	PKF16M424	PKF16M425	PKF16M433	PKF16M434	PKF16M435	-	PKF16M444	PKF16M445
32 A	PKF32M413	PKF32M414	PKF32M415	PKF32M423	PKF32M424	PKF32M425	PKF32M433	PKF32M434	PKF32M435	-	PKF32M444	PKF32M445
IP67 16 A	PKF16M713	PKF16M714	PKF16M715	PKF16M723	PKF16M724	PKF16M725	PKF16M733	PKF16M734	PKF16M735	-	PKF16M744	PKF16M745
32 A	PKF32M713	PKF32M714	PKF32M715	PKF32M723	PKF32M724	PKF32M725	PKF32M733	PKF32M734	PKF32M735	-	PKF32M744	PKF32M745
63 A	-	81476	81477	81478	81479	81480	-	81482	81483	-	81485	81486
125 A	-	81488	81489	81490	81491	81492	-	81494	81495	-	81497	81498



Technical data

			FAST connection, without screws	SCREW connection
				
Main characteristics			They can be wall-mounted to supply appliances with wander plugs. They are very compact in dimensions.	
Degree of protection	According to IEC 60529	16 and 32 A	IP44	IP44
	According to EN 62262	Against external mechanical impacts	- IK08	IP67 IK08
Materials			Housing made of self-extinguishing polymer Sleeves made of brass	Housing made of self-extinguishing polymer Sleeves made of brass
Resistance to fire and abnormal heat	According to IEC 60695-2-11	Glow wire test	750°C	750°C
Connection terminals			Without screws and without stripping the conductor	Captive screws, completely loosened

Connection

		FAST connection, without screws			SCREW connection		
Rating	Cable diameter	Cable entry	Maximum cross section of conductors	Cable diameter	Cable entry	Maximum cross section of conductors	
(In)		IP44	IEC 60309-1/A1, 60309-2/A1 Stranded wire cables / flexible cables		IP44 / IP67	Solid cables / stranded wire cables / flexible cables	
16 A	Max 21,0 mm	M25 threaded nut	1 to 2.5 mm ²	Max 21,0 mm	M25 threaded nut+cable gland	1 to 4 mm ²	
32 A			2.5 to 6 mm ²			2.5 to 10 mm ²	

Code of Wall-mounted sockets

Rating	Rated voltage											
	100 - 130 V AC			200 - 250 V AC			380 - 415 V AC			480 - 500 V AC		
Poles and wires	2P + \neq	3P + \neq	3P+N + \neq	2P + \neq	3P + \neq	3P+N + \neq	2P + \neq	3P + \neq	3P+N + \neq	2P + \neq	3P + \neq	3P+N + \neq
FAST connection												
IP44 16 A	PKY16W413	PKY16W414	PKY16W415	PKY16W423	PKY16W424	PKY16W425	PKY16W433	PKY16W434	PKY16W435	-	PKY16W444	PKY16W445
32 A	PKY32W413	PKY32W414	PKY32W415	PKY32W423	PKY32W424	PKY32W425	PKY32W433	PKY32W434	PKY32W435	-	PKY32W444	PKY32W445
SCREW connection												
IP44 16 A	PKF16W413	PKF16W414	PKF16W415	PKF16W423	PKF16W424	PKF16W425	PKF16W433	PKF16W434	PKF16W435	-	PKF16W444	PKF16W445
32 A	PKF32W413	PKF32W414	PKF32W415	PKF32W423	PKF32W424	PKF32W425	PKF32W433	PKF32W434	PKF32W435	-	PKF32W444	PKF32W445
SMALL - SCREW connection												
IP67 16 A	PKF16W713	PKF16W714	PKF16W715	PKF16W723	PKF16W724	PKF16W725	PKF16W733	PKF16W734	PKF16W735	-	PKF16W744	PKF16W745
32 A	PKF32W713	PKF32W714	PKF32W715	PKF32W723	PKF32W724	PKF32W725	PKF32W733	PKF32W734	PKF32W735	-	PKF32W744	PKF32W745



PKY32W435





PKF16W434



PKF32W734

Technical data

			Sockets with Back box	
				
Main characteristics			They can be wall-mounted to supply appliances with wander plugs.	
Degree of protection	According to IEC 60529	16 and 32 A	IP44	
		63 A and 125 A	IP67	
	According to EN 62262	Against external mechanical impacts	IK08	
Materials			Housing made of self-extinguishing polymer	
			Sleeves made of nickel-plated brass	
			Screws, pins and springs made of stainless steel	
Pilot contact			Available in the 63 A and 125 A	
Resistance to fire and abnormal heat	According to IEC 60695-2-11	Glow wire test	850°C	
Connection terminals			Captive screws, completely loosened	

Connection

		Sockets with Back box		
Rating (In)	Cable entry	Maximum cross section of conductors		
		IP44 / IP67 Fair-lead	IP67 Cable gland	Solid and stranded wire flexible cables
16 A	8 - 15 mm	PG16 (PG21 5P)	1 to 4 mm ²	
32 A	11.5 - 21 mm	PG21	2.5 to 10 mm ²	
63 A	-	PG36	6 to 25 mm ²	
125 A	-	PG48	16 to 70 mm ²	

Code of wall-mounted socket with Back box

Rating	Rated voltage												
	100 - 130 V AC			200 - 250 V AC			380 - 415 V AC			480 - 500 V AC			
Poles and wires	2P + \neq	3P + \neq	3P+N + \neq	2P + \neq	3P + \neq	3P+N + \neq	2P + \neq	3P + \neq	3P+N + \neq	2P + \neq	3P + \neq	3P+N + \neq	
IP44 16 A	83101	83102	83103	83104	83105	83106	83107	83108	83109	-	83111	83112	
	32 A	83113	83114	83115	83116	83117	83118	83119	83120	83121	-	83123	83124
IP67 16 A	83151	83152	83153	83154	83155	83156	83157	83158	83159	-	83161	83162	
	32 A	83163	83164	83165	83166	83167	83168	83169	83170	83171	-	83173	83174
	63 A	-	81176	81177	81178	81179	81180	-	81182	81183	-	81185	81186
125 A	-	81188	81189	81190	81191	81192	-	81194	81195	-	81197	81198	

PG149166



83104

PG149171



83171

PG149143



81195

PratiKa sockets

Low voltage

Back box wall-mounted for PratiKa panel and sockets

Technical data

			Back box wall-mounted
			
Main characteristics			They can be wall-mounted to supply appliances with wander plugs. The back box permit the use of panel sockets PratiKa, both screw and fast version, to create a wall installation with horizontal outlet.
Degree of protection	According to IEC 60529	16 and 32 A	IP44
	According to EN 62262	Against external mechanical impacts	IP67 (box + panel socket)
Materials			Housing made of self-extinguishing polymer Screws, made of stainless steel
Pilot contact			Available in the 63 A and 125 A
Resistance to fire and abnormal heat	According to IEC 60695-2-11	Glow wire test	850°C

Connection

			Back box wall-mounted
Rating (In)			Cable entry
16 A and 32 A			IP44/IP67
			Cable diameter
		M25	Max 21 mm
Possibility to make in/out in the bottom part of the box (position for drilling M20, M25 or M32). Threaded caps M25 supplied with gasket IP67			



Code of Back box wall mounted for fitting PratiKa panel sockets IP44 / IP67





Description poles	Code
Small sized BOX	
Permits the mounting of socket (16 A 3 or 4 poles) with flange 65 x 85	PKZ085
Big sized BOX	
Permits the mounting of socket (16 A 5 poles and 32 A 3 or 4 or 5 poles) with flange 90 x 100	PKZ100
Description poles	Code
Cable gland	
M25	PKZ025
M32	PKZ032



Example

PKZ100 + PKY16G734

Technical data

			FAST connection, without screws	
			Angled sockets	Straight sockets
				
				
Main characteristics			They can be mounted on a plate, panel or machine to supply appliance with wander plugs.	
Degree of protection	According to IEC 60529	16 and 32 A	IP44	IP44
	According to EN 62262	Against external mechanical impacts	IP67	IP67
Materials			Housing made of self-extinguishing polymer	Housing made of self-extinguishing polymer
			Sleeves made of brass	Sleeves made of brass
			Pins and springs made of stainless steel	Pins and springs made of stainless steel
Resistance to fire and abnormal heat	According to IEC 60695-2-11	Glow wire test	850°C	850°C
Flange dimensions (IP44 - IP67)	16 A	2P + \perp	65 x 85 mm	65 x 85 mm
		3P + \perp	65 x 85 mm	65 x 85 mm
		3P+N + \perp	90 x 100 mm	90 x 100 mm
	32 A	2P + \perp	90 x 100 mm	90 x 100 mm
		3P + \perp	90 x 100 mm	90 x 100 mm
		3P+N + \perp	90 x 100 mm	90 x 100 mm
Connection terminals			Without screws and without stripping the conductor	Without screws and without stripping the conductor

Connection

			FAST connection, without screws	
			Angled sockets	Straight sockets
Rating			Maximum cross section of conductors	
(In)			IEC 60309-1/A1, 60309-2/A1 Stranded wire cables / flexible cables	
16 A			1 to 2.5 mm ²	1 to 2.5 mm ²
32 A			2.5 to 6 mm ²	2.5 to 6 mm ²

Code of panel-mounted angled and straight sockets

Rating	Rated voltage											
	100 - 130 V AC			200 - 250 V AC			380 - 415 V AC			480 - 500 V AC		
Poles and wires	2P + \perp	3P + \perp	3P+N + \perp	2P + \perp	3P + \perp	3P+N + \perp	2P + \perp	3P + \perp	3P+N + \perp	2P + \perp	3P + \perp	3P+N + \perp
FAST connection, without screws - Angled sockets												
IP44 16 A	PKY16F413	PKY16F414	PKY16F415	PKY16F423	PKY16F424	PKY16F425	PKY16F433	PKY16F434	PKY16F435	-	PKY16F444	PKY16F445
32 A	PKY32F413	PKY32F414	PKY32F415	PKY32F423	PKY32F424	PKY32F425	PKY32F433	PKY32F434	PKY32F435	-	PKY32F444	PKY32F445
IP67 16 A	PKY16F713	PKY16F714	PKY16F715	PKY16F723	PKY16F724	PKY16F725	PKY16F733	PKY16F734	PKY16F735	-	PKY16F744	PKY16F745
32 A	PKY32F713	PKY32F714	PKY32F715	PKY32F723	PKY32F724	PKY32F725	PKY32F733	PKY32F734	PKY32F735	-	PKY32F744	PKY32F745
FAST connection, without screws - Straight sockets												
IP44 16 A	PKY16G413	PKY16G414	PKY16G415	PKY16G423	PKY16G424	PKY16G425	PKY16G433	PKY16G434	PKY16G435	-	PKY16G444	PKY16G445
32 A	PKY32G413	PKY32G414	PKY32G415	PKY32G423	PKY32G424	PKY32G425	PKY32G433	PKY32G434	PKY32G435	-	PKY32G444	PKY32G445
IP67 16 A	PKY16G713	PKY16G714	PKY16G715	PKY16G723	PKY16G724	PKY16G725	PKY16G733	PKY16G734	PKY16G735	-	PKY16G744	PKY16G745
32 A	PKY32G713	PKY32G714	PKY32G715	PKY32G723	PKY32G724	PKY32G725	PKY32G733	PKY32G734	PKY32G735	-	PKY32G744	PKY32G745



PKY16F423



PKY32F734



PKY16G423



PKY32G734

Technical data

			SCREW connection Angled sockets	Straight sockets
				
Main characteristics			They can be mounted on a plate, panel or machine to feed appliances with wander plugs.	
Degree of protection	According to IEC 60529	16 and 32 A	IP44	IP44
		63 and 125 A	IP67	IP67
	According to EN 62262	Against external mechanical impacts	IK08	IK08
Materials			Housing made of self-extinguishing polymer Sleeves made of brass for 16 A and 32 A Sleeves made of nickel-plated brass for 63 A and 125 A Pins and springs made of stainless steel	Housing made of self-extinguishing polymer -
Pilot contact			Available in the 63 A and 125 A	Available in the 63 A and 125 A
Resistance to fire and abnormal heat	According to IEC 60695-2-11	Glow wire test	850°C	850°C
Flange dimensions (IP44 - IP67)	16 A	2P + \perp , 3P + \perp	65 x 85 mm	65 x 85 mm
	32 A	3P+N + \perp	90 x 100 mm	90 x 100 mm
	63 A		100 x 107 mm	100 x 107 mm
	125 A		110 x 114 mm	110 x 114 mm
Connection terminals			Captive screws, completely loosened	Captive screws, completely loosened

Connection

		SCREW connection Angled sockets	Straight sockets
Rating (In)		Maximum cross section of conductors	
		Solid cables / stranded wire cables / flexible cables	
16 A		1 to 4 mm ²	1 to 4 mm ²
32 A		2.5 to 10 mm ²	2.5 to 10 mm ²
63 A		6 to 25 mm ²	6 to 25 mm ²
125 A		16 to 70 mm ²	16 to 70 mm ²

Code of panel-mounted angled and straight sockets

Rating	Rated voltage											
	100 - 130 V AC			200 - 250 V AC			380 - 415 V AC			480 - 500 V AC		
Poles and wires	2P + \perp	3P + \perp	3P+N + \perp	2P + \perp	3P + \perp	3P+N + \perp	2P + \perp	3P + \perp	3P+N + \perp	2P + \perp	3P + \perp	3P+N + \perp
SCREW connection - Angled sockets												
IP44 16 A	PKF16F413	PKF16F414	PKF16F415	PKF16F423	PKF16F424	PKF16F425	PKF16F433	PKF16F434	PKF16F435	-	PKF16F444	PKF16F445
32 A	PKF32F413	PKF32F414	PKF32F415	PKF32F423	PKF32F424	PKF32F425	PKF32F433	PKF32F434	PKF32F435	-	PKF32F444	PKF32F445
IP67 16 A	PKF16F713	PKF16F714	PKF16F715	PKF16F723	PKF16F724	PKF16F725	PKF16F733	PKF16F734	PKF16F735	-	PKF16F744	PKF16F745
32 A	PKF32F713	PKF32F714	PKF32F715	PKF32F723	PKF32F724	PKF32F725	PKF32F733	PKF32F734	PKF32F735	-	PKF32F744	PKF32F745
63 A	-	81276	81277	81278	81279	81280	-	81282	81283	-	81285	81286
125 A	-	81288	81289	81290	81291	81292	-	81294	81295	-	81297	81298
SCREW connection - Straight sockets												
IP44 16 A	PKF16G413	PKF16G414	PKF16G415	PKF16G423	PKF16G424	PKF16G425	PKF16G433	PKF16G434	PKF16G435	-	PKF16G444	PKF16G445
32 A	PKF32G413	PKF32G414	PKF32G415	PKF32G423	PKF32G424	PKF32G425	PKF32G433	PKF32G434	PKF32G435	-	PKF32G444	PKF32G445
IP67 16 A	PKF16G713	PKF16G714	PKF16G715	PKF16G723	PKF16G724	PKF16G725	PKF16G733	PKF16G734	PKF16G735	-	PKF16G744	PKF16G745
32 A	PKF32G713	PKF32G714	PKF32G715	PKF32G723	PKF32G724	PKF32G725	PKF32G733	PKF32G734	PKF32G735	-	PKF32G744	PKF32G745
63 A	-	81676	81677	81678	81679	81680	-	81682	81683	-	81685	81686
125 A	-	81688	81689	81690	81691	81692	-	81694	81695	-	81697	81698

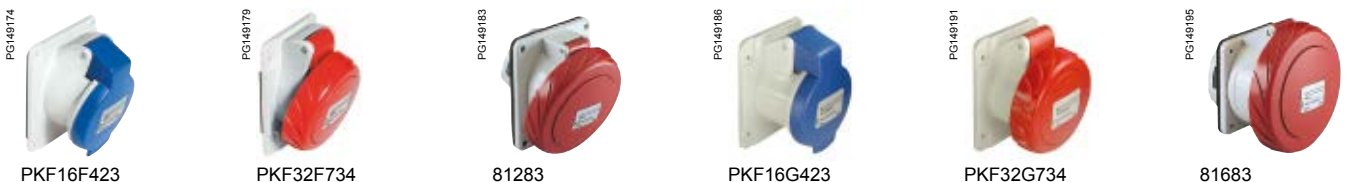

Technical data

			Multiple adapters
			
Main characteristics			They can be used for temporary situations only and in certain industrial environments where there is no danger of explosions or fire.
Conceived in conformity with standards			IEC 60309-1, IEC 60309-2 and IEC 60309-4
Degree of protection	According to IEC 60529	16 and 32 A	IP44
	According to EN 62262	Against external mechanical impacts	IP67
Materials			IK08
			Housing made of self-extinguishing polymer
			Pins made of nickel-plated brass
			Sleeves made of brass
LEDs when lighted show the presence of Voltage in each plug's phases, it is not a protection			Stainless steel screw
Resistance to fire and abnormal heat			If it should be off, control the switch-board before usage or maintenance
According to IEC 60695-2-11	Glow wire test		850°C

Code of multiple adapter - 1 Plug + 2 Socket-outlets

Plug side			Socket side				
Rating	Poles	Rated voltage	No.	Rating	Poles	Rated voltage	
IP44 16 A	2P + \perp	200 - 250 V AC	2	16 A	2P + \perp	200 - 250 V AC	PKZM403
	3P + \perp	380 - 415 V AC	2	16 A	3P + \perp	380 - 415 V AC	PKZM406
IP67 16 A	2P + \perp	100 - 130 V AC	2	16 A	2P + \perp	100 - 130 V AC	PKZM701
		200 - 250 V AC	2	16 A	2P + \perp	200 - 250 V AC	PKZM703
		380 - 415 V AC	2	16 A	2P + \perp	380 - 415 V AC	PKZM705
	3P + \perp	2	16 A	3P + \perp	380 - 415 V AC	PKZM706	

Code of multiple adapter - 1 Plug + 3 Socket-outlets

Plug side			Socket side				
Rating	Poles	Rated voltage	No.	Rating	Poles	Rated voltage	
IP44 16 A	2P + \perp	200 - 250 V AC	3	16 A	2P + \perp	200 - 250 V AC	PKZM409
	3P + \perp	380 - 415 V AC	3	16 A	3P + \perp	380 - 415 V AC	PKZM412
	32 A	3P+N + \perp	380 - 415 V AC	2	16 A	2P + \perp	200 - 250 V AC
1				32 A	3P+N + \perp	380 - 415 V AC	
IP67 16 A	2P + \perp	100 - 130 V AC	3	16 A	2P + \perp	100 - 130 V AC	PKZM707
		200 - 250 V AC	3	16 A	2P + \perp	200 - 250 V AC	PKZM709
		380 - 415 V AC	3	16 A	2P + \perp	380 - 415 V AC	PKZM712
	32 A	3P+N + \perp	380 - 415 V AC	2	16 A	3P + \perp	200 - 250 V AC
1				32 A	3P+N + \perp	380 - 415 V AC	



PKZM403



PKZM712

PratiKa sockets

Low voltage

Domestic panel-mounted sockets

Functions

They are available in the panel-mounted versions and can be fitted directly on Kaedra enclosures or on wall-boxes.

Technical data

Main characteristics			
Colors	Blue, black or gray (RAL 7035)		
Degree of protection	According to IEC 60529	IP54 and IP65	
	According to EN 62262	Against external mechanical impacts	
Materials	Housing made of self-extinguishing polymer		
	Pins and springs made of stainless steel		
	Spring loaded cover		
Resistance to fire and abnormal heat	According to IEC 60695-2-11	Glow wire test	850°C



81139



81140



81141



81142



PKS52B



PKS61B

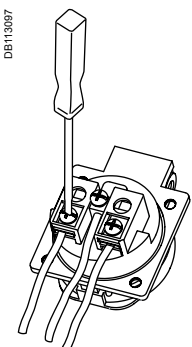

PKS51G
Version with back tightening terminals

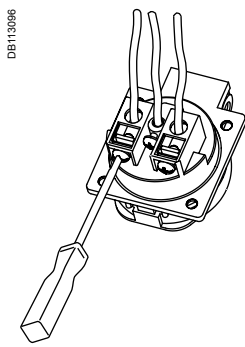

PKS52G
Version with side tightening terminals

Code for domestic sockets 65 x 85 - IP65

Rating	Rated voltage	Type	Number of sockets	Code grey
	250 V AC			
Poles	2P + \neq	Standard		
10 - 16 A		Italy	2	81139
			1 (dual - use)	81146
		French	1	81140
		Germany	1	81141
		England	1	81144
		Switzerland	1	81145

Code for RJ 45 support 65 x 85 - IP65

Description	Code grey
With 1 adapter RJ45 Infra+	81142
With 2 adapters RJ45 Infra+	81143

Code for domestic sockets 50 x 50 - IP54

Rating	Rated voltage	Type	Code		
	250 V AC				
Poles	2P + \neq	Standard	Grey	Blue	Black
With back tightening terminals					
10 - 16 A		Germany	PKS51G	PKS51B	PKS51N
		French	PKN51G	PKN51B	PKN51N
With side tightening terminals					
10 - 16 A		Germany	PKS52G	PKS52B	PKS52N
		French	PKN52G	PKN52B	PKN52N

Code for domestic sockets 65 x 85 - IP54

Rating	Rated voltage	Type	Code		
	250 V AC				
Poles	2P + \neq	Standard	Grey	Blue	Black
With back tightening terminals					
10 - 16 A		Germany	PKS61G	PKS61B	PKS61N
		French	PKN61G	PKN61B	PKN61N
With side tightening terminals					
10 - 16 A		Germany	PKS62G	PKS62B	PKS62N
		French	PKN62G	PKN62B	PKN62N

Sockets 16 - 32 A



Rated current	Poles and wires	Freq. Hz	Rated voltage	Clock position of secondary keyway	Wander sockets	
					IP44	IP67
16 A	2P	50/60	20-25 V	s.r.	82401	82451
	3P	50/60		s.r.	82402	82452
	2P	50/60	40-50 V	12 h	82403	82453
	3P	50/60		12 h	82404	82454
	2P	100/200	20-25 V / 40-50 V	4 h	82405	82455
	3P	100/200		4 h	82406	82456
	2P	401/500		11 h	82411	82461
	3P	401/500		11 h	82412	82462
	2P	---	20-25 V / 40-50 V	10 h	82413	82463
32 A	2P	50/60	20-25 V	s.r.	82415	82465
	3P	50/60		s.r.	82416	82466
	2P	50/60	40-50 V	12 h	82417	82467
	3P	50/60		12 h	82418	82468
	2P	100/200	20-25 V / 40-50 V	4 h	82419	82469
	3P	100/200		4 h	82420	82470
	2P	401/500		11 h	82425	82475
	3P	401/500		11 h	82426	82476
	2P	---	20-25 V / 40-50 V	10 h	82427	82477

Technical data, see page

38

Sockets with safety transformer

Unika





Rated power	Rated voltage		Number and type of sockets	Panel mounted version		Wall-mounted version	
	Primary	Secondary		IP44	IP65	IP44	IP65
160 VA	230 V	24 V	1 x 2P 16 A	82026	82076	83026	83076
	400 V	24 V	1 x 2P 16 A	82027	82077	83027	83077
	230 V	24 V	-	-	-	-	-
	400 V	24 V	-	-	-	-	-

Technical data, see page

44

							
Panel-mounted straight sockets Flange 65 x 65				Wall-mounted sockets			
IP44		IP67		IP44		IP44	
82901		82951		82101		82151	
82902		82952		82102		82152	
82903		82953		82103		82153	
82904		82954		82104		82154	
82905		82955		82105		82155	
82906		82956		82106		82156	
82911		82961		82111		82161	
82912		82962		82112		82162	
82913		82963		82113		82163	
82915		82965		82115		82165	
82916		82966		82116		82166	
82917		82967		82117		82167	
82918		82968		82118		82168	
82919		82969		82119		82169	
82920		82970		82120		82170	
82925		82975		82125		82175	
82926		82976		82126		82176	
82927		82977		82127		82177	
39							

Isoblock					
Number and type of sockets			Wall-mounted version		
			IP65		
1 x 2P 16 A			82061		
1 x 2P 16 A			82063		
2 x 2P 16 A			82062		
2 x 2P 16 A			82064		
49					

Technical data

			Wander sockets
			
Main characteristics			Designed to supply fixed or movable equipments by a flexible cable.
Degree of protection	According to IEC 60529	16 and 32 A	IP44
	According to EN 62262	Against external mechanical impacts	IP67
Materials			IK08
			Housing made of self-extinguishing polymer
			Sleeves made of nickel-plated brass
Resistance to fire and abnormal heat	According to IEC 60695-2-11	Glow wire test	Screws, pins and springs made of stainless steel
			850°C
Connection terminals			Captive screws, completely loosened

Connection

			Wander sockets		
Rating (In)	Cable entry		Maximum cross section of conductors		
	IP44 / IP67 Fair-lead	IP67 Cable gland	Solid and stranded wire flexible cables		
16 A	6 - 23 mm	PG21	4 to 10 mm ²		
32 A	6 - 23 mm	PG21	4 to 10 mm ²		

Code of wander sockets

Rating	Rated voltage											
	20-25 V 50/60 Hz		40-50 V 50/60 Hz		20-25 V / 40-50 V 100-200 Hz				401-500 Hz		20-25 V / 40-50 V ---	
Poles and wires	2P	3P	2P	3P	2P	3P	2P	3P	2P	3P	2P	3P
IP44 16 A	82401	82402	82403	82404	82405	82406	82411	82412	82413	-	-	-
	82415	82416	82417	84518	82419	82420	82425	82426	82427	-	-	-
IP67 16 A	82451	82452	82453	82454	82455	82456	82461	82462	82463	-	-	-
	82465	82466	82467	82468	82469	82470	82475	82476	82477	-	-	-





82402



82468

Technical data

			Panel-mounted sockets	Wall-mounted sockets
				
Main characteristics			They can be mounted on a plate, panel or machine to supply appliances with wander plugs.	They can be wall-mounted to supply appliances with wander plugs.
Degree of protection	According to IEC 60529	16 and 32 A	IP44 IP67	IP44 IP67
	According to EN 62262	Against external mechanical impacts	IK08	IK08
Materials			Housing made of self-extinguishing polymer Sleeves made of nickel-plated brass Screws, pins and springs made of stainless steel	Housing made of self-extinguishing polymer Sleeves made of nickel-plated brass Screws, pins and springs made of stainless steel
Resistance to fire and abnormal heat	According to IEC 60695-2-11	Glow wire test	850°C	850°C
Connection terminals			Captive screws, completely loosened	Captive screws, completely loosened

Connection

Rating (In)	Panel-mounted sockets	Wall-mounted sockets		
	Maximum cross section of conductors Solid and stranded wire flexible cables	Cable entry IP44 / IP67 Fair-lead	IP67 Cable gland	Maximum cross section of conductors Solid and stranded wire flexible cables
16 A	1 to 2,5 mm ²	6 - 23 mm	PG21	4 to 10 mm ²
32 A	2,5 to 6 mm ²	6 - 23 mm	PG21	4 to 10 mm ²

Code of panel-mounted sockets

Rating	Rated voltage											
	20-25 V 50/60 Hz		40-50 V 50/60 Hz		20-25 V / 40-50 V 100-200 Hz				401-500 Hz		20-25 V / 40-50 V ---	
Poles and wires	2P	3P	2P	3P	2P	3P	2P	3P	2P	3P	2P	3P
Flange 65 x 65 mm												
IP44 16 A	82901	82902	82903	82904	82905	82906	82911	82912	82913	-	-	-
32 A	82915	82916	82917	84918	82919	82920	82925	82926	82927	-	-	-
IP67 16 A	82951	82952	82953	82954	82955	82956	82961	82962	82963	-	-	-
32 A	82965	82966	82967	82968	82969	82970	82975	82976	82977	-	-	-

Code of wall-mounted sockets

Rating	Rated voltage											
	20-25 V 50/60 Hz		40-50 V 50/60 Hz		20-25 V / 40-50 V 100-200 Hz				401-500 Hz		20-25 V / 40-50 V ---	
Poles and wires	2P	3P	2P	3P	2P	3P	2P	3P	2P	3P	2P	3P
IP44 16 A	82101	82102	82103	82104	82105	82106	82111	82112	82113	-	-	-
32 A	82115	82116	82117	84118	82119	82120	82125	82126	82127	-	-	-
IP67 16 A	82151	82152	82153	82154	82155	82156	82161	82162	82163	-	-	-
32 A	82165	82166	82167	82168	82169	82170	82175	82176	82177	-	-	-



82901



82954



82101





82168

PratiKa sockets

With interlock switch

Unika - Isoblock / Selection guide

Sockets with interlock switch

					Unika - Panel-mounted version							
												
Rated nominal	Poles and wires	Freq. Hz	Rated voltage	Clock position of contact	Without protection			Protected by FUSE carrier			With DIN rail	
					IP44	IP65	IP65	IP44	IP65	IP65	IP65	
16 A	2P + \perp	50/60	100-130 V	4 h	82028	82078	-	82128	82178	-	-	
	3P + \perp	50/60		4 h	82029	82079	-	82129	82179	-	-	
	3P+N + \perp	50/60		4 h	82030	82080	-	82130	82180	-	-	
	2P + \perp	50/60	200-250 V	6 h	82031	82081	-	82132	82181	-	-	
	3P + \perp	50/60		9 h	82032	82082	-	82132	82182	-	-	
	3P+N + \perp	50/60		9 h	82033	82083	-	82133	82183	-	-	
	2P + \perp	50/60	380-415 V	9 h	82034	82084	-	82134	82184	-	-	
	3P + \perp	50/60		6 h	82035	82085	-	82135	82185	-	-	
	3P+N + \perp	50/60		6 h	82036	82086	-	82136	82186	-	-	
	3P + \perp	50/60	480-500 V	7 h	82037	82087	-	82137	82187	-	-	
	3P+N + \perp	50/60		7 h	82038	82088	-	82138	82188	-	-	
	3P+N + \perp	50/60		4 h	82039	82089	-	82139	82189	-	-	
32 A	2P + \perp	50/60	100-130 V	4 h	82040	82090	-	82140	82190	-	-	
	3P + \perp	50/60		4 h	82041	82091	-	82141	82191	-	-	
	3P+N + \perp	50/60		4 h	82042	82092	-	82142	82192	-	-	
	2P + \perp	50/60	200-250 V	6 h	82043	82093	-	82143	82193	-	-	
	3P + \perp	50/60		9 h	82044	82094	-	82144	82194	-	-	
	3P+N + \perp	50/60		9 h	82045	82095	-	82145	82195	-	-	
	2P + \perp	50/60	380-415 V	9 h	82046	82096	-	82146	82196	-	-	
	3P + \perp	50/60		6 h	82047	82097	-	82147	82197	-	-	
	3P+N + \perp	50/60		6 h	-	-	-	-	-	-	-	
	3P + \perp	50/60	380-440 V	3 h	-	-	-	-	-	-	-	
	3P+N + \perp	50/60		7 h	82048	82098	-	82148	82198	-	-	
	3P+N + \perp	50/60		7 h	82049	82099	-	82149	82199	-	-	
63 A	3P + \perp	50/60	100-130 V	4 h	-	-	PKB63T514	-	-	PKB63V514	PKB63U514	
	3P+N + \perp	50/60		4 h	-	-	PKB63T515	-	-	PKB63V515	PKB63U515	
	2P + \perp	50/60		6 h	-	-	PKB63T523	-	-	PKB63V523	PKB63U523	
	3P + \perp	50/60	200-250 V	9 h	-	-	PKB63T524	-	-	PKB63V524	PKB63U524	
	3P+N + \perp	50/60		9 h	-	-	PKB63T525	-	-	PKB63V525	PKB63U525	
	3P + \perp	50/60		6 h	-	-	PKB63T534	-	-	PKB63V534	PKB63U534	
	3P+N + \perp	50/60	380-415 V	6 h	-	-	PKB63T535	-	-	PKB63V535	PKB63U535	
	3P + \perp	50/60		7 h	-	-	PKB63T544	-	-	PKB63V544	PKB63U544	
	3P+N + \perp	50/60		7 h	-	-	PKB63T545	-	-	PKB63V545	PKB63U545	
	3P + \perp	50/60	480-500 V	7 h	-	-	-	-	-	-	-	
	3P+N + \perp	50/60		7 h	-	-	-	-	-	-	-	
	3P+N + \perp	50/60		7 h	-	-	-	-	-	-	-	
Technical data, see page					42							

Sockets with safety transformer

					Unika - Panel-mounted version	
						
Rated power VA	Number and type of sockets	Rated voltage		IP44	IP65	
		Primary	Secondary			
16 A	1 x 2P 16 A	230 V	24 V	82026	82076	
	1 x 2P 16 A	400 V		82027	82077	
Technical data, see page					44	

Wall and embedded box

		Unika - Panel-mounted version	
			
		Number of sockets	Embedded box
		1	83924
		1 unmarked walls	-
		1 wall with knock-outs	-
		1 with junction box	-
		2 with junction box	-
		3 with junction box	-
Technical data, see page		46	

Unika - Wall-mounted version



Isoblock - Wall-mounted version



Without protection

Protected by FUSE carrier

With DIN rail

Protected by FUSE carrier

With DIN rail

IP44	IP65	IP65	IP44	IP65	IP65	IP65	IP65	IP65	IP65	
83028	83078	-	83128	83178	-	-	-	-	-	
83029	83079	-	83129	83179	-	-	-	-	-	
83030	83080	-	83130	83180	-	-	-	-	-	
83031	83081	-	83131	83181	-	-	83454 □	82754 □	-	
83032	83082	-	83132	83182	-	-	-	-	-	
83033	83083	-	83133	83183	-	-	-	-	-	
83034	83084	-	83134	83184	-	-	-	-	-	
83035	83085	-	83135	83185	-	-	83458 □	82758 □	-	
83036	83086	-	83136	83186	-	-	83459 □	82759 □	-	
83037	83087	-	83137	83187	-	-	-	-	-	
83038	83088	-	83138	83188	-	-	-	-	-	
83039	83089	-	83139	83189	-	-	-	-	-	
83040	83090	-	83140	83190	-	-	-	-	82764 ■	
83041	83091	-	83141	83191	-	-	-	-	-	
83042	83092	-	83142	83192	-	-	83466 □	83791 □	82766 ■	
83043	83093	-	83143	83193	-	-	-	-	-	
83044	83094	-	83144	83194	-	-	-	-	-	
83045	83095	-	83145	83195	-	-	-	-	-	
83046	83096	-	83146	83196	-	-	83470 □	83795 □	82770 ■	
83047	83097	-	83147	83197	-	-	83471 □	83796 □	82771 ■	
-	83299	-	-	83399	-	-	-	83799 □	-	
83048	83098	-	83148	83198	-	-	-	-	-	
83049	83099	-	83149	83199	-	-	-	-	-	
-	-	PKB63P514	-	-	PKB63R514	PKB63Q514	-	-	-	
-	-	PKB63P515	-	-	PKB63R515	PKB63Q515	-	-	-	
-	-	PKB63P523	-	-	PKB63R523	PKB63Q523	-	-	-	
-	-	PKB63P524	-	-	PKB63R524	PKB63Q524	82879 ■	-	-	
-	-	PKB63P525	-	-	PKB63R525	PKB63Q525	-	-	-	
-	-	PKB63P534	-	-	PKB63R534	PKB63Q534	82882 ■	-	82782 ■	
-	-	PKB63P535	-	-	PKB63R535	PKB63Q535	82883 ■	-	82783 ■	
-	-	PKB63P544	-	-	-	PKB63Q544	82885 ■	-	-	
-	-	PKB63P545	-	-	-	PKB63Q545	82886 ■	-	82786 ■	
43							48			

Unika - Wall-mounted version



Isoblock - Wall-mounted version



IP44	IP65	
83026	83076	1P
83027	83077	2P

IP65		IP65
82061 ■		82062 ■
82063 ■		82064 ■

Unika - Wall-mounted version



Modular basis

Isoblock - Wall-mounted version



Modular panels

Wall mounting box			Modular panels			With junction box			With modular enclosures		
16 - 32 A	63 A		Number and type sockets								
-	-	-	1 x B16	-	83925 □	-	83325 □	-	-	-	-
83919	-	-	2 x B16	-	83926 □	-	83326 □	-	-	-	-
83920	PKB002	-	1 x 32/63	-	83927 ■	-	83327 ■	-	-	-	-
-	-	83921	-	-	-	-	-	-	-	-	-
-	-	-	83922	-	-	-	-	-	-	-	-
-	-	-	-	83923	-	-	-	-	-	-	-
46			47			50					

□ = Sockets 106 mm width. ■ = Sockets 144 mm width.

PratiKa sockets

With interlock switch

Unika series / Panel-mounted version

Technical data

		Protected by disconnect fuse carriers	Without protection / DIN rail
		Their technical, functional and aesthetic qualities make them particularly suitable for installation in the tertiary and industry sectors.	
Main characteristics		The switch can be externally padlocked into position "0" and "1".	
Colour		RAL 7035	RAL 7035
Degree of protection	According to IEC 60529	IP44 and IP65	IP44 and IP65
	According to EN 62262	Against external mechanical impacts	IK09
Materials		Housing made of self-extinguishing polymer External pins, pins and screws made of stainless steel	Housing made of self-extinguishing polymer External pins, pins and screws made of stainless steel
Construction	According to IEC 60309-2-4	IP44 and IP65	IP44 and IP65
Resistance to fire and abnormal heat	According to IEC 60695-2-11	Glow wire test	750°C
Operating voltage (400 V)	According to IEC 60947-3	16 A 32 A 63 A	20 A (AC22) / 9.5 kW (AC23A) 32 A (AC22) / 16 kW (AC23A) 63 A (AC22) / 22 kW (AC23A) / 15.5 kW (AC23)
Disconnect fuse carriers	Complying with IEC 60269	For CH 10,3 x 38 type fuse	-
Fuse holder version	Fuse holders NEOZED type D02 (non supplied with the product) The door to accede to the fuse holders can be:	■ Opened only with the switch in position "0" Equipped with key-lock (available as accessory) in its handle	- - -
DIN rail version	DIN rail up to 4,5 modules The door to accede to the modular devices can be:	- - -	■ DIN rail up to 4,5 modules Opened only when the switch is on the "0" position Equipped with key-lock (available as accessory) in its handle
Connection terminals		Captive screws	Captive screws

Connection

	Protected by disconnect fuse carriers	Without protection
Rating (In)	Maximum cross section of conductors	
16 A, 32 A	10 mm ²	10 mm ²
63 A	35 mm ²	35 mm ²

Code of panel-mounted sockets Unika

Rating	Rated voltage											
	100 - 130 V			200 - 250 V			380 - 415 V			480 - 500 V		
Poles and wires	2P + \neq	3P + \neq	3P+N + \neq	2P + \neq	3P + \neq	3P+N + \neq	2P + \neq	3P + \neq	3P+N + \neq	2P + \neq	3P + \neq	3P+N + \neq
Protected by disconnect fuse carriers												
IP44 16 A	82128	82129	82130	82131	82132	82133	82134	82135	82136	-	82137	82138
32 A	82139	82140	82141	82142	82143	82144	82145	82146	82147	-	82148	82149
IP65 16 A	82178	82179	82180	82181	82182	82183	82184	82185	82186	-	82187	82188
32 A	82189	82190	82191	82192	82193	82194	82195	82196	82197	-	82198	82199
63 A	-	PKB63V514	PKB63V515	PKB63V523	PKB63V524	PKB63V525	-	PKB63V534	PKB63V535	-	-	-
With DIN rail												
IP65 63 A	-	PKB63U514	PKB63U515	PKB63U523	PKB63U524	PKB63U525	-	PKB63U534	PKB63U535	-	PKB63U544	PKB63U545
Without protection												
IP44 16 A	82028	82029	82030	82031	82032	82033	82034	82035	82036	-	82037	82038
32 A	82039	82040	82041	82042	82043	82044	82045	82046	82047	-	82048	82049
IP65 16 A	82078	82079	82080	82081	82082	82083	82084	82085	82086	-	82087	82088
32 A	82089	82090	82091	82092	82093	82094	82095	82096	82097	-	82098	82099
63 A	-	PKB63T514	PKB63T515	PKB63T523	PKB63T524	PKB63T525	-	PKB63T534	PKB63T535	-	PKB63T544	PKB63T545



82147

82197

82031

82041

PKB63T534

PKB63V534

PKB63U534

PratiKa sockets

With interlock switch

Unika series / Wall-mounted version

Technical data

		Protected by disconnect fuse carriers	Without protection / DIN rail
		Their technical, functional and aesthetic qualities make them particularly suitable for installation in the tertiary and industry sectors.	
Main characteristics		The switch can be externally padlocked into position "0" and "1".	
Colour		RAL 7035	RAL 7035
Degree of protection	According to IEC 60529	IP44 and IP65	IP44 and IP65
	According to EN 62262	Against external mechanical impacts	IK09
Materials		Housing made of self-extinguishing polymer	Housing made of self-extinguishing polymer
		External pins, pins and screws made of stainless steel	External pins, pins and screws made of stainless steel
Construction	According to IEC 60309-2-4	IP44 and IP65	IP44 and IP65
Resistance to fire and abnormal heat	According to IEC 60695-2-11	Glow wire test	750°C
Operating voltage (400 V)	According to IEC 60947-3	16 A 32 A 63 A	20 A (AC22) / 9.5 kW (AC23A) 32 A (AC22) / 16 kW (AC23A) 63 A (AC22) / 22 kW (AC23A) / 15.5 kW (AC23)
Disconnect fuse carriers	Complying with IEC 60269	For CH 10,3 x 38 type fuse	-
Fuse holder version	Fuse holders NEOZED type D02 (non supplied with the product)	■	-
	The door to accede to the fuse holders can be:	Opened only with the switch in position "0"	-
		Equipped with key-lock (available as accessory) in its handle	-
DIN rail version	DIN rail up to 4,5 modules	-	■ DIN rail up to 4,5 modules
	The door to accede to the modular devices can be:	-	Opened only when the switch is on the "0" position
		-	Equipped with key-lock (available as accessory) in its handle
Wall-mounted version		Cable entry (from the top)	Cable entry (from the top)
		Complete with fair-lead for 25 mm Max. Diameter cables and conduits, and/or PG21 cable gland	-
Connection terminals		Screw head plugs fused not supplied	Screw head plugs fused not supplied
		Captive screws	Captive screws

Connection

		Protected by disconnect fuse carriers	Without protection
Rating (In)		Maximum cross section of conductors	
16 A, 32 A		10 mm ²	10 mm ²
63 A		35 mm ²	35 mm ²

Code of wall-mounted sockets Unika

Rating	Rated voltage											
	100 - 130 V			200 - 250 V			380 - 415 V			480 - 500 V		
Poles and wires	2P + ⚡	3P + ⚡	3P+N + ⚡	2P + ⚡	3P + ⚡	3P+N + ⚡	2P + ⚡	3P + ⚡	3P+N + ⚡	2P + ⚡	3P + ⚡	3P+N + ⚡
Protected by disconnect fuse carriers												
IP44 16 A	83128	83129	83130	83131	83132	83133	83134	83135	83136	-	83137	83138
32 A	83139	83140	83141	83142	83143	83144	83145	83146	83147	-	83148	83149
IP65 16 A	83178	83179	83180	83181	83182	83183	83184	83185	83186	-	83187	83188
32 A	83189	83190	83191	83192	83193	83194	83195	83196	83197	-	83198	83199
63 A	-	PKB63R514	PKB63R515	PKB63R523	PKB63R524	PKB63R525	-	PKB63R534	PKB63R535	-	-	-
With DIN rail												
IP65 63 A	-	PKB63Q514	PKB63Q515	PKB63Q523	PKB63Q524	PKB63Q525	-	PKB63Q534	PKB63Q535	-	PKB63Q544	PKB63Q545
Without protection												
IP44 16 A	83028	83029	83030	83031	83032	83033	83034	83035	83036	-	83037	83038
32 A	83039	83040	83041	83042	83043	83044	83045	83046	83047	-	83048	83049
IP65 16 A	83078	83079	83080	83081	83082	83083	83084	83085	83086	-	83087	83088
32 A	83089	83090	83091	83092	83093	83094	83095	83096	83097	-	83098	83099
63 A	-	PKB63P514	PKB63P515	PKB63P523	PKB63P524	PKB63P525	-	PKB63P534	PKB63P535	-	PKB63P544	PKB63P545



PratiKa sockets

With interlock switch

Unika series / Panel-mounted and wall-mounted version

Technical data

			Unika with safety transformer SELV 
			Units fitted with safety transformers, in conformity with IEC742 standards.
Main characteristics			<p>Their modular size enables them to be used with all the components of the PratiKa Unika series.</p> <p>They are used to power circuits with a voltage rating of 50 V maximum, to protect users against direct and indirect contacts, in conformity with IEC 60364 standards.</p>
Colour			RAL 7035
Degree of protection	According to IEC 60529		IP44 and IP65
	According to EN 62262	Against external mechanical impacts	IK09
Materials			Housing made of self-extinguishing polymer Screws pins and springs made of stainless steel
Resistance to fire and abnormal heat	According to IEC 60695-2-11	Glow wire test	750°C
The unit is rated	According to IEC 61558-2-6		Class II
Rated power of safety transformer			160 VA under continuous use
Operating voltage			230: 24 V 400: 24 V
Transformer protected against short-circuit			By the cylindrical fuses supplied
Power supply switch on the primary controlled			By a special mechanism upon the insertion of the plug
Available as follows			Fitted with one very-low-voltage IEC 60309 socket, 24 V 2P Wall-mounted Complete with fair-lead for 25 mm Max. Diameter cables and conduits, and/or PG21 cable gland Supplied with screw head cover
Connection terminals			Captive screws

Connection

		Unika with safety transformer SELV 
Rating (In)	160 VA	Maximum cross section of conductors 6 mm ²

Code of panel-mounted Unika with safety transformer

Rated power	Rated voltage		Number and type of sockets	Code
	Primary	Secondary		
IP44 160 VA	230 V	24 V	1 x 16 A	82026
	400 V	24 V	1 x 16 A	82027
IP65 160 VA	230 V	24 V	1 x 16 A	82076
	400 V	24 V	1 x 16 A	82077

Code of wall-mounted Unika with safety transformer

Rated power	Rated voltage		Number and type of sockets	Code
	Primary	Secondary		
IP44 160 VA	230 V	24 V	1 x 16 A	83026
	400 V	24 V	1 x 16 A	83027
IP65 160 VA	230 V	24 V	1 x 16 A	83076
	400 V	24 V	1 x 16 A	83077

PG 148095



82026

PG 148096



82076

PG 148097



83026

PG 148098



83076

PratiKa sockets

With interlock switch

Unika series / Installation flexibility

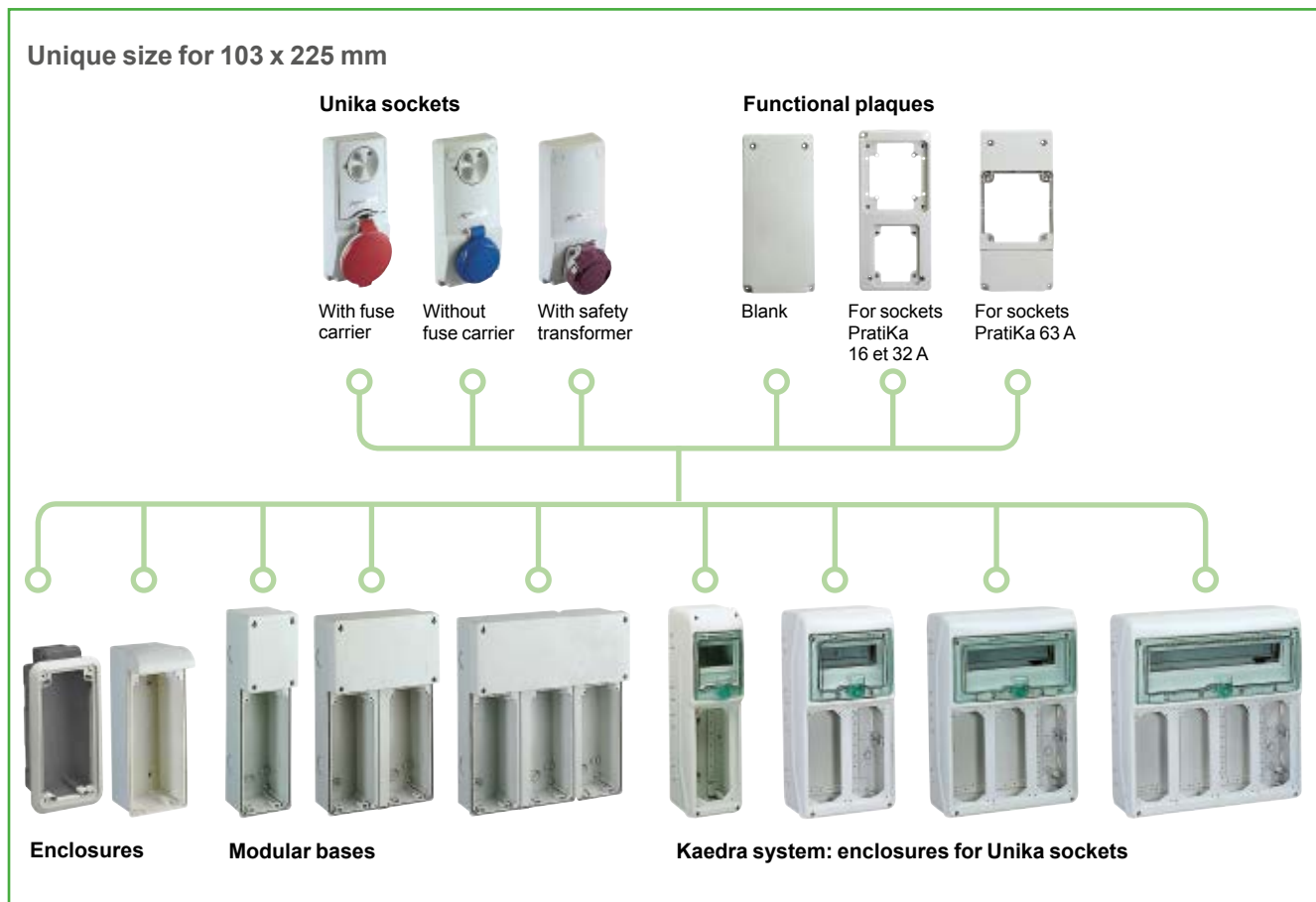

Installation flexibility

The Unika sockets with interlock switch are suitable for wall and embedded mounting or panel mounting. The offer complains a complete range of enclosures for different installation ways: individual emplacement or combination in banks.

Its compact size permits to have panel boards with small overall dimensions.

The Unika sockets are equipped with the new five thread which enables a fast fixing on all enclosures.



PratiKa sockets

With interlock switch

Unika series / Wall and embedded-box

Technical data

			Wall-mounting box	Embedded box
			These can be fitted either wall-mounted or wall-embedded or in the Unika series interlocked socket panels.	
Main characteristics			They enable wall-mounted installation of sockets with interlock or sockets with safety transformers. On the upper part there is a section with a small cover intended for increased volumes of wiring.	They enable panel-mounted installation of sockets with interlock or sockets with safety transformers.
Colour			RAL 7035	RAL 7035 for frame/RAL 7016 for box
Degree of protection	According to IEC 60529		IP65	IP65 (After installation)
	According to EN 62262	Against external mechanical impacts	IK09	IK09
Materials			Housing made of self-extinguishing polymer Stainless steel screws	Housing made of self-extinguishing polymer Stainless steel screws
Complete insulation characteristics	According with EN 60439-1		■	-
Resistance to fire and abnormal heat	According to IEC 60695-2-11	Glow wire test	750°C	750°C
Wall and embedded-box			Cable entry from the top	-
			Fair-lead for 25 mm max.diameter cables and conduits	-
			Version with knockout holes M32 mm diam. for association	-
			Supplied with screw head covers	-
Dimensions (L x H x P)			103 x 250 x 70	103 x 235 x 70

Code of wall-mounting box

Degree of protection	Code
IP65 16 - 32 A With unmarked walls	83919
_____ Walls with knock-outs	83920
63 A	PKB002

Code of embedded box

Degree of protection	Code
IP65	83924

PG148089



83919

PB102659



PKB002

PG148090



83924

PratiKa sockets

With interlock switch

Unika series / Modular bases

Technical data

		Modular bases
		For wall-mounted fitting in combinations of one or more Unika series interlocked sockets and other PratiKa series sockets.
Main characteristics		They enable wall-mounted fitting of sockets with interlock or sockets with safety transformers. On the upper part there is a box incorporated designed for easy power feeding and wiring distribution.
Colour		RAL 7035
Degree of protection	According to IEC 60529	IP65 (After installation)
	According to EN 62262	Against external mechanical impacts
Materials		Housing made of self-extinguishing polymer Stainless steel screws
Complete insulation characteristics	According with EN 60439-1	■
Resistance to fire and abnormal heat	According to IEC 60695-2-11	Glow wire test 650°C
Modular bases		Cable entry from the top Fair-lead for 25 mm max diameter cables and conduits Version with knockout holes M32 mm diam. for association Supplied with screw head covers

Code of modular basis

Degree of protection	Dimensions			Number of sockets	Code
	H	W	D		
IP65	350	105	70	1	83921
	350	210	70	2	83922
	350	315	70	3	83923

Code of auxiliary components for modular basis

Description	Code
Association kit M32 for modular basis and boxes with 2 nipples and nuts diam. 32 mm	13934

Code of functional plaques

For closing the openings 103 x 225 of different Unika and Kaedra system enclosures

Description	Code
Blank plaques ■ Marked for fixing: <input type="checkbox"/> panel mounted straight PratiKa sockets for low and extra-low voltage with flange 65 x 65 mm or 75 x 75 mm <input type="checkbox"/> 1 or 2 devices diam. 22.2 mm.	13143
Plaques with 2 openings ■ 1 of 65 x 85 mm for direct fixing of angled PratiKa sockets 16 A 2P+⊥ and 3P+⊥ or domestic sockets ■ 1 of 90 x 100 mm for direct fixing of angled PratiKa sockets 16 A 4P+⊥ and 32 A	13142
Plaques with 1 opening ■ 107 x 114 mm for direct fixing of angled or straight PratiKa sockets 63 A	13144



83921



83922



83923



13143



13142



13144

PratiKa sockets

With interlock switch

Isoblock series / Wall-mounted version

Technical data

		Protected by fuse carriers
		Thanks to their high performances they are intended for installation in environments where there are aggressive chemical agents, oils and grease, and frequent jets of water or accidental shocks.
Main characteristics		They ensure the control and local isolating of parts of the plant or utilities so as to enable intervention on electrical circuits or machines in total safety.
Colour		RAL 7035
Degree of protection	According to IEC 60529	IP65
	According to EN 62262	Against external mechanical impacts
Materials		Housing made of self-extinguishing polymer Screws, pins and springs made of stainless steel
Construction	According to IEC 60309-2-4	IP65
Resistance to fire and abnormal heat	According to IEC 60695-2-11	Glow wire test 850°C
Operating voltage (400 V)	Rated current	16 A 32 A 63 A
		20 A (AC22) / 9.5 kW (AC23A) IEC 60947-3 32 A (AC22) / 16 kW (AC23A) IEC 60947-3 63 A (AC22) / 30 kW (AC23A) IEC 60947-3
The switch can be externally padlocked into position		"0" and "1"
Disconnect fuse carriers	Complying with IEC 60269	For CH 10,3 x 38
Access lid to fuse carriers can be opened		Only with the switch in position "0"
Fuses not supplied		■
Wall-mounted version		Cable entry from the top Complete with fair-lead for 25 mm Max. Diameter cables and conduits, and/or: ■ PG21 cable gland for 16 A and 32 A ■ PG29 for 63 A
Connection terminals		Captive screw

Connection

		Protected by fuse carriers
Rating		Maximum cross section of conductors
16 A and 32 A		10 mm ²
63 A		35 mm ²

Code of Isoblock sockets

Rating	Type	Rated voltage												
		100 - 130 V			200 - 250 V			380 - 415 V			480 - 500 V			
Poles and wires		2P + \neq	3P + \neq	3P+N + \neq	2P + \neq	3P + \neq	3P+N + \neq	2P + \neq	3P + \neq	3P+N + \neq	2P + \neq	3P + \neq	3P+N + \neq	
With fuse carriers 10.3 x 38 mm														
IP65 16 A	B16	-	-	-	83454	-	-	-	83458	83459	-	-	-	-
32 A	B16	-	-	-	83466	-	-	-	83470	83471	-	-	-	-
With fuse carriers E33														
IP65 63 A	B32/63	-	-	-	-	82879	-	-	82882	82883	-	82885	82886	-



83454



83471



82883

PratiKa sockets

With interlock switch

Isoblock series / Wall-mounted version

Technical data

	With DIN rail	With safety transformer SELV 
	Thanks to their high performances they are intended for installation in environments where there are aggressive chemical agents, oils and grease, and frequent jets of water or accidental shocks.	For use either singly or in combination units by means of the Isoblock sectional panels, in environments where there are aggressive chemical agents, oils, grease, frequent, heavy jets of water and accidental shocks.
Main characteristics	They have a DIN rail for modular protection devices.	These enable powering of circuits with a voltage rating of 50 V maximum, to protect users against direct and indirect contacts, in conformity with IEC364 standards.
Colour	RAL 7035	RAL 7035
Degree of protection	According to IEC 60529 IP65 According to EN 62262 Against external mechanical impacts IK10	IP65 IK10
Materials	Housing made of self-extinguishing polymer Screws, pins and springs made of stainless steel	Housing made of self-extinguishing polymer Screws, pins and springs made of stainless steel
Construction	According to IEC 60309-2-4 IP65	IP65
Resistance to fire and abnormal heat	According to IEC 60695-2-11 Glow wire test 850°C	850°C
The unit is rated	According to IEC 60558-2-6	Class II
Operating voltage (400 V)	Rated current 16 A (according to IEC 60947-3) 32 A 63 A	- - -
Operating voltage	160 VA	230/24 V or 400/24 V
Rated power of safety transformer	-	160 VA under continuous use
Transformer protected against short-circuit	-	By CH10, 3x38 the cylindrical fuses supplied
Power supply switch on the primary controlled	-	By a special mechanism upon the insertion of the plug
The switch can be externally padlocked into position	"0" and "1"	-
Access lid to fuse carriers can be opened	Only with the switch in position "0"	-
Compartment for modular devices fitted with symmetrical DIN rail	16 A and 32 A 32 A and 63 A	- -
Fitted with one or two very-low voltage sockets	-	24 V, 2P
Wall-mounted version	Cable entry from the top Complete with fair-lead for 25 mm Max. Diameter cables and conduits, and/or: ■ PG21 cable gland for 16 A and 32 A ■ PG29 for 63 A	Complete with fair-lead for 25 mm Max. Diameter cables and conduits, and/or PG21 cable gland
Connection terminals	Captive screw	Captive screw

Connection

	With DIN rail	With safety transformer SELV 
Rating	Maximum cross section of conductors	
16 A and 32 A	10 mm ²	-
63 A	35 mm ²	-
160 VA	-	6 mm ²

Code of Isoblock sockets

Rating	Type	Rated voltage												
		100 - 130 V			200 - 250 V			380 - 415 V			480 - 500 V			
Poles and wires		2P + \neq	3P + \neq	3P+N + \neq	2P + \neq	3P + \neq	3P+N + \neq	2P + \neq	3P + \neq	3P+N + \neq	2P + \neq	3P + \neq	3P+N + \neq	
With DIN rail - 4.5 modules														
IP65	16 A	B16	-	-	-	82754	-	-	-	82758	82759	-	-	-
	32 A	B16	-	-	-	83791	-	-	-	83795	83796	-	-	-
With DIN rail - 6 modules														
IP65	32 A	B32/63	-	-	-	82764	-	-	-	82770	82771	-	-	-
	63 A	B32/63	-	-	-	-	82766	-	-	-	82782	82783	-	82786

Code of Isoblock sockets with safety transformer SELV

Rated power	Rated voltage		Number and type of sockets	Code
	Primary	Secondary		
IP65 160 VA	230 V	24 V	1 x 16 A	82061
	400 V	24 V	1 x 16 A	82063
160 VA	230 V	24 V	2 x 16 A	82062
	400 V	24 V	2 x 16 A	82064



82754



82771



82783



82061



82062

PratiKa sockets

With interlock switch

Isoblock series / Modular panels

Technical data

		Modular panels
		For the installation of Isoblock series interlocked sockets in environments where there are aggressive chemical agents, oils and grease, frequent, heavy jets of water or accidental shocks
Main characteristics		<p>These enable wall-mounted fitting of sockets with interlock or safety transformers and are available in two versions:</p> <ul style="list-style-type: none"> ■ version with integrated box designed to enable power feeding and wiring distribution ■ version with control box designed to accommodate one or more modular protection devices fitted to the symmetrical DIN rail.
Colour		RAL 7035
Degree of protection	According to IEC 60529	IP65
	According to EN 62262	Against external mechanical impacts
Materials		Housing made of self-extinguishing polymer Screws made of stainless steel Walls with knock our loch for cable entry from the top and for association
Complete insulation characteristics	According with EN 60439-1	■
Construction	According to IEC 60670-1	IP65
Resistance to fire and abnormal heat	According to IEC 60695-2-11	Glow wire test 850°C

Code for modular panels with junction boxes

Type	Dimensions			Number of sockets	Code
	H	W	D		
B16	535	111	11 + 65	1	83925
2B16	535	222	17 + 100	2	83926
B32/63	535	151	17 + 100	1	83927

Code for modular panels with modular enclosures

Type	Module	Dissipated power	Dimensions			Number of sockets	Code
			H	W	D		
	18 mm						
B16	4	9 watt	535	111	11 + 65	1	83325
2B16	10	14 watt	535	222	17 + 100	2	83326
B32/63	6	11 watt	535	151	17 + 100	1	83327

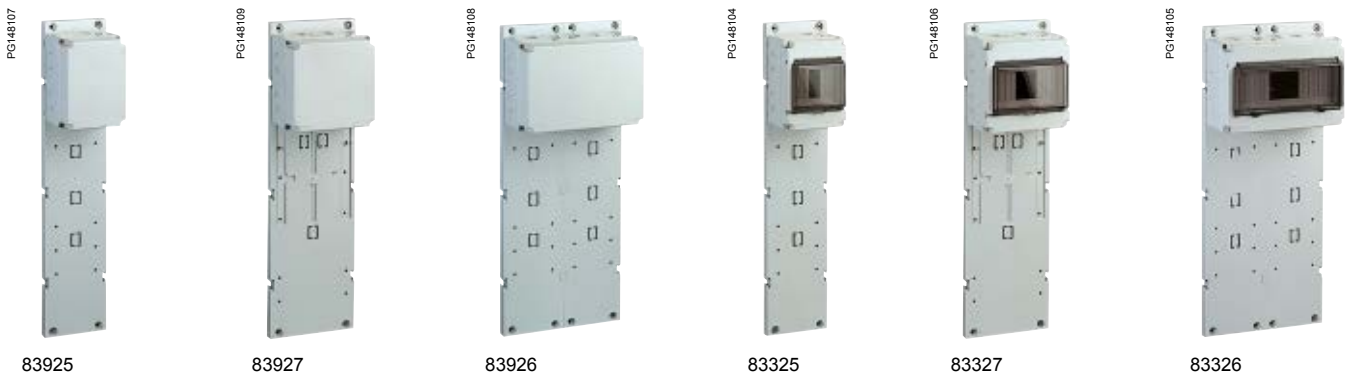

Technical data

		Sockets with circuit breaker and electrical interlock
		These are characterized by a thermal-magnetic circuit breaker, with or without earth-fault protection which is activated only when the plug is fully inserted in the socket. If the plug is removed while under load, the circuit breaker will trip automatically.
Main characteristics		
Colour		RAL 7035
Degree of protection	According to IEC 60529	IP65
	According to EN 62262	Against external mechanical impacts
Materials		Housing made of self-extinguishing polymer Screw made of thermoplastic material
Resistance to fire and abnormal heat	According to IEC 60695-2-11	Glow wire test 960°C
Moulded case automatic thermal-magnetic circuit breaker		With or without differential relay
Rotary switch which can be externally padlocked into position		"0" and "1"
Reset of the switch		From the outside when triggered
Socket fitted with pilot contact		For controlling the 24 V electrical interlock
Earth fault protection	Sensitivity (I Δ n)	Adjustable 0.03 - 0.3 - 1 - 3 - 10 A
	Time delay	Adjustable 0 - 60 - 150 - 310 ms
Red warning light		Signal tripping of earth fault protection
Connection terminals		Captive screw Cable entry from the top Complete with thickness flange and PG42 cable gland Terminal block guard at the circuit breaker entry

Connection

		Sockets with circuit breaker and electrical interlock
Rating		Maximum cross section of conductors
63 A and 125 A		95 mm ²

■ Scheme with thermal magnetic circuit breaker

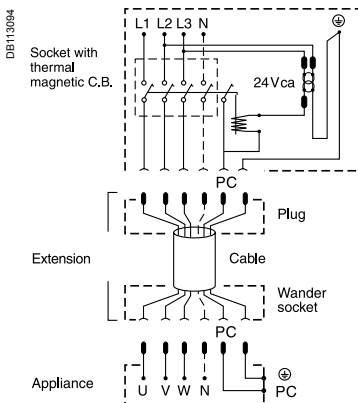

■ Scheme with thermal magnetic circuit breaker and earth fault protection

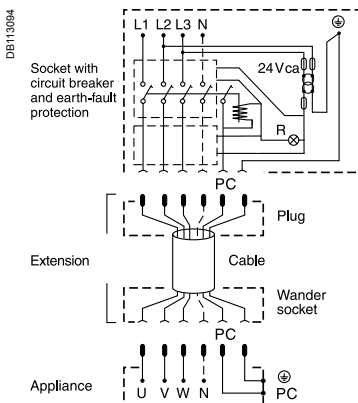

Circuit breaker characteristics

Rated current (In)	Tripping thresholds		Ultimate breaking capacity (kA rms)		
	Thermal (tr)	Magnetic (tm)	220/240V	380/415V	500V
63 A	Adjustable	500 A	85	36	30
125 A	0.8... 1 x In	1250 A	85	36	30

Code for interlocked socket

Rating	Rated voltage							
	100 - 130 V		200 - 250 V		380 - 415 V		480 - 500 V	
Poles and wires	3P + \neq	3P+N + \neq	3P + \neq	3P+N + \neq	3P + \neq	3P+N + \neq	3P + \neq	3P+N + \neq
With thermal-magnetic circuit breaker								
IP65 63 A	-	-	82479	-	82482	82483	82485	-
125 A	-	-	82491	-	82494	82495	82497	-
With thermal-magnetic circuit breaker and earth fault protection								
IP65 63 A	-	-	-	-	82432	82433	-	-
125 A	-	-	-	-	82444	82445	-	-



82482

PratiKa plugs 32 A for containers

Rated current	Poles and wires	Freq.	Rated voltage	Clock position of contact	Wander plugs	
					FAST connect	SCREW connect
32 A	3P + \perp	50/60 Hz	380 - 415 V AC	3 h	IP67 PKX32M7C4	IP67 PKE32M7C4
Technical data, see page					54	



SCREW connect

PratiKa sockets 32 A for containers

Rated current	Poles and wires	Freq.	Rated voltage	Clock position of contact	Panel mounted sockets		
					Wander sockets	Angled	Straight
32 A	3P + \perp	50/60 Hz	380 - 415 V AC	3 h	FAST connect IP67 PKY32M7C4	FAST connect IP67 PKY32F7C4	FAST connect IP67 PKY32G7C4
Technical data, see page					54		



Interlocked Unika

Rated current	Poles and wires	Freq.	Rated voltage	Clock position of contact	Wall mounted sockets	
						With fuse carriers
32 A	3P + \perp	50/60 Hz	400 - 440 V AC	3 h	IP65 83299	IP65 83399
Technical data, see page					54	





Wall-mounted plugs with back box

SCREW connect

IP67

81599

54



Panel-mounted plugs

SCREW connect

IP67

83899



Wander sockets

SCREW connect

IP67

PKF32M7C4

54



Panel mounted sockets

Angled

SCREW connect

IP67

PKF32F7C4



Wall-mounted sockets

SCREW connect

IP67

PKF32W7C4



With back box

SCREW connect

IP67

81199

Interlocked Isoblock



Sockets - 4.5 mod.

With rail DIN

IP65

83799

54

The PratiKa plugs and sockets for containers are designed to power refrigerated containers in ports, railway stations, airports, as well as on board container-ships.

The IP67 protection, use of nickel-plated contacts, stainless steel screws, pins and springs and high performance plastic materials, combine in ensuring maximum protection and guaranteed functioning also in highly aggressive and corrosive environments.

The solution for safe connections worldwide

In accordance with standards, these plugs and sockets are available in the following versions:

- 32 A - 3P+E,
- voltage rating 400 - 440 V,
- clock-position 3 hours,
- degree of protection IP67.

Functions

They are designed for supplying low-voltage power to loades or equipment fitted with domestic or similar plugs.

- PratiKa wander plugs.
- PratiKa wander plugs angled 90°.
- PratiKa wall mounted plugs.
- PratiKa panel-mounted plugs.
- PratiKa wander sockets.
- PratiKa small wall-mounted sockets.
- PratiKa wall-mounted sockets.
- PratiKa panel-mounted angled sockets.
- PratiKa panel-mounted straight sockets.
- Interlocked sockets Unika.
- Interlocked sockets Unika with fuse protection.
- Interlocked sockets Isoblock with DIN rail.

Technical data

		SCREW connection
		
Main characteristics		
Degree of protection	According to IEC 60529	IP67 (IP65 for interlocked sockets)
	According to EN 62262	IK08 (IK09 for interlocked sockets)
Materials	Against external mechanical impacts	Housing made of self-extinguishing polymer Pins made of nickel-plated brass Stainless steel screws Springs and pins made of stainless steal
Resistance to fire and abnormal heat	According to IEC 60695-2-11	850°C (750°C for Unika)
Connection terminals		Captive screws, completely loosened

Connection

		SCREW connection		Maximum cross section of conductors
Rating		Cable entry		
(In)		IP67 Cable gland	IP67 Cable clamp	Stranded wire flexible cables
32 A		PG21 PratiKa	11.5 - 21 mm PratiKa	Flexible 2.5 to 10 mm ² for panel and wall versions 2.5 to 6 mm ² for wander versions 2.5 to 10 mm ² for interlocked versions



PKX32M7C4



PKY32M7C4



PKF32W7C4



81599



81199



83899



PKY32F7C4



PKY32G7C4



83399



83799

Code of wander IP67

Rating	Rated voltage	Clock position	Frequency
	400 - 440 V AC	H	Hz
Poles	3P + \neq		
Plugs			
32 A PratiKa FAST	PKX32M7C4	3	50-60
PratiKa SCREW	PKE32M7C4	3	50-60
Sockets			
32 A PratiKa FAST	PKY32M7C4	3	50-60
PratiKa SCREW	PKF32M7C4	3	50-60

Code of small wall-mounted IP67

Rating	Rated voltage	Clock position	Frequency
	400 - 440 V AC	H	Hz
Poles	3P + \neq		
Sockets			
32 A	PKF32W7C4	3	50-60

Code of wall mounted IP67

Rating	Rated voltage	Clock position	Frequency
	400 - 440 V AC	H	Hz
Poles	3P + \neq		
Plugs			
32 A	81599	3	50-60
Sockets			
32 A	81199	3	50-60

Code of panel-mounted IP67

Rating	Rated voltage	Clock position	Frequency
	400 - 440 V AC	H	Hz
Poles	3P + \neq		
Plugs			
32 A	83899	3	50-60
Caps for plugs	83936		
Angled sockets			
32 A PratiKa FAST	PKY32F7C4	3	50-60
PratiKa SCREW	PKF32F7C4		
Straight sockets			
32 A PratiKa FAST	PKY32G7C4	3	50-60
PratiKa SCREW	PKF32G7C4		

Interlocked Unika IP65 - wall mounted



Rating	Rated voltage	Clock position	Frequency
	400 - 440 V AC	H	Hz
Poles	3P + \neq		
Sockets			
32 A	83299	3	50-60
Sockets with fuse carriers			
32 A	83399	3	50-60

Interlocked Isoblock IP65 - 4.5 mod.

Rating	Rated voltage	Clock position	Frequency
	400 - 440 V AC	H	Hz
Poles	3P + \neq		
Sockets with rail DIN			
32 A	83799	3	50-60



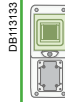









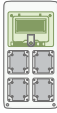
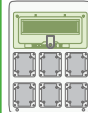

(*) Refs. of sockets enclosure without terminal block / Ref. of modular enclosure equipped with terminal blocks

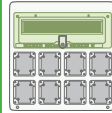
Watertight Mini-enclosures

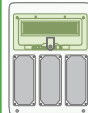
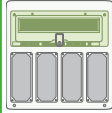
			
Number of modules	1	4	4
	13175	13176	13177

Watertight enclosures

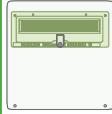
The modular dimension of Kaedra enclosures allows their combination vertically or horizontally.

mm	138	236	340	448		
335						
Number of modules			12 + 1	12 + 1		
			13180	13191		
460						
Number of modules		5	8	12 + 1	2 x 12	18 + 1
	13993	13178	13179	13181	13983	13182
						
Number of modules		5	8	12 + 1		18 + 1
		13185	13186	13187		13188
						
Number of modules		5	8	12 + 1		18 + 1
		13189	13190	13192		13193
610						
	13994					

Technical data

		Enclosures for sockets *	
			
Main characteristics		<p>They are designed for the quick installation of PratiKa sockets thanks to the specific opening which can be closed by special plaques.</p> <p>These enclosures are available in three different versions:</p> <ul style="list-style-type: none"> ■ with 65 x 85 or 90 x 100 opening for PratiKa sockets ■ with 103 x 225 opening for Unika panel mounted sockets ■ with blank panel, for fitting universal sockets. 	
Colour		RAL 7035	
Degree of protection	According to IEC 60529	IP65	
	According to EN 62262	Against external mechanical impacts	IK09
Materials		Housing made of self-extinguishing polymer Knock-out holes for association accessories M32 Screws head plugs	
Complete insulation	According to EN 61439-1	<input type="checkbox"/>	■
Resistance to fire and abnormal heat	According to IEC 60695-2-11	Glow wire test	650°C
Inferior and superior walls		With knock-outs for cable entry	

PB102274



Code for Mini enclosures for PratiKa sockets

Dimensions			Modules	Opening	Supplied plaques	Dissipated power	Code
H	W	D	18 mm	65 x 85	Blank	(W)	
248	98	98	4	1 vert.	-	10	13175
310	98	98	4	2 horizont.	1	10	13176
392	98	98	4	3 horizont.	1	10	13177

PB102275



Code for enclosures for PratiKa sockets

Dimensions			Modules	Opening	Supplied plaques		Dissipated power	Code
H	W	D	18 mm	90 x 100	Blank	Intermediate	(W)	
460	138	160	5	2	1	2	12	13178
460	236	160	8	4	1	4	15	13179
335	340	160	12+1	3	1	3	28	13180
460	340	160	12+1	6	2	6	28	13181
460	448	160	18+1	8	2	8	39	13182

PB102276



Code for enclosures for Unika with interlock switch

Dimensions			Modules	Opening	Supplied plaques	Dissipated power	Code
H	W	D	18 mm	103 x 225	Blank	(W)	
460	138	160	5	1	-	12	13185
460	236	160	8	2	1	15	13186
460	340	160	12+1	3	1	28	13187
460	448	160	18+1	4	1	39	13188

PB102277



Code for universal enclosures for sockets

Dimensions			Modules	Dissipated power	Code
H	W	D	18 mm	(W)	
460	138	160	5	12	13189
460	236	160	8	15	13190
335	340	160	12+1	28	13191
460	340	160	18+1	28	13192
460	448	160	18+1	39	13193

(*) Offer supply without terminal blocks (see p. 60)

Direct mounting

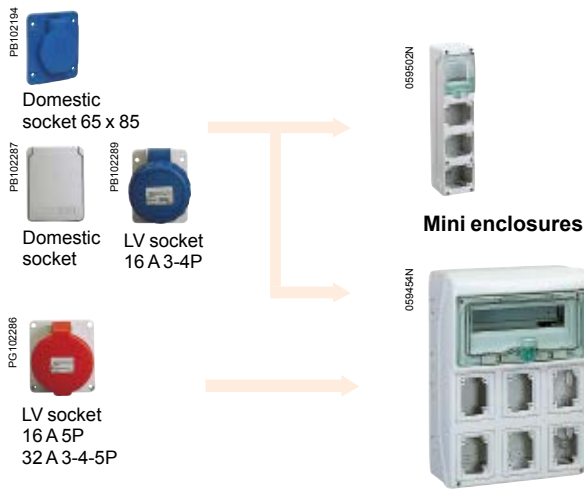

Mini enclosures

Indirect mounting

These products can be mounted on Kaedra trough the use of plaques

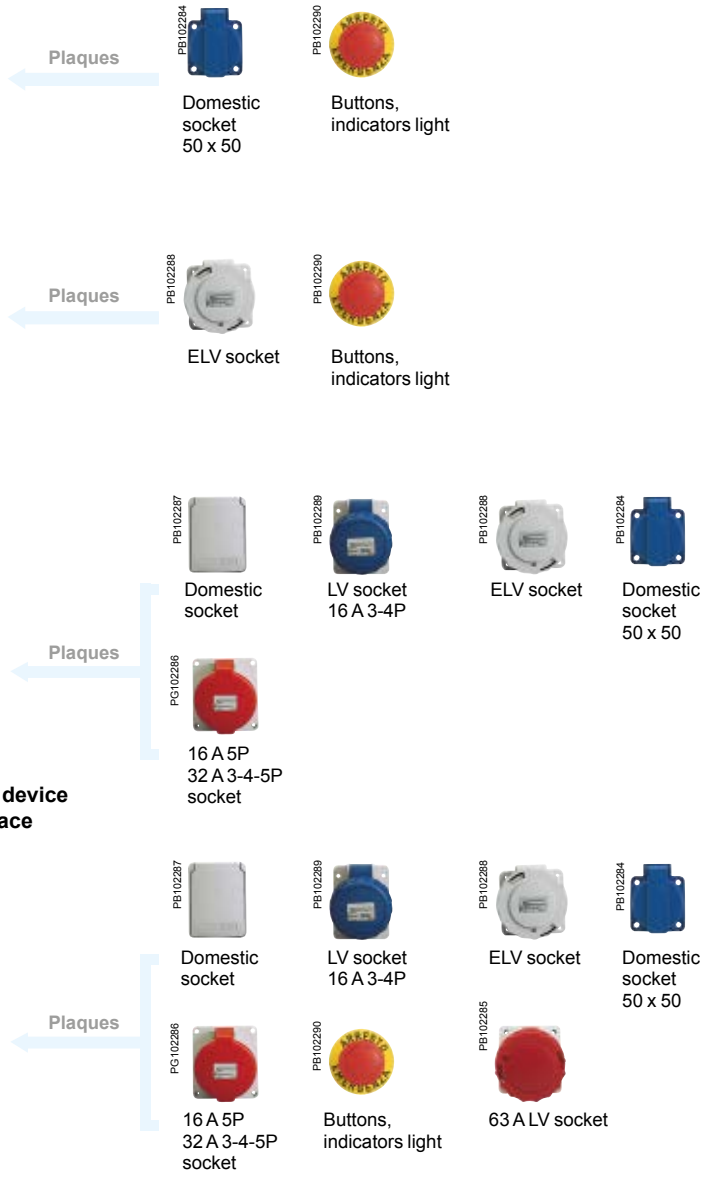

Buttons, indicators light

LV and ELV sockets with interlock switch Unika



All Kaedra enclosures for sockets are delivered with an intermediate plaque (13136) already mounted on each opening, remove it before mounting a 16 A 5P or 32 A 3-4-5P socket.

Kaedra for modular device with interface have the plaque 13138 already mounted on each opening.

The standard openings

All enclosures for sockets and enclosures for interface have different openings for functional plaques. There are three standard dimensions:

- 65 x 85 mm, for direct fixing of PratiKa angled sockets of 16 A 2P+E and 3P+E or of domestic sockets
- 90 x 100 mm, for direct fixing of PratiKa in the enclosures for sockets, these opening are normally delivered with intermediate plaques code 13136
- 103 x 225 mm, for direct fixing of Unika sockets with interlock switch and relative functional plaques.

Indirect mounting

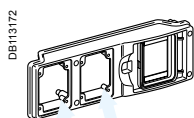

Mini enclosures

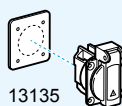

Domestic socket
50 x 50 mm

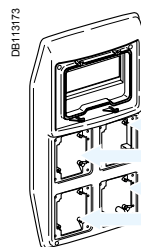

Enclosures for sockets

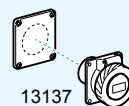

ELV socket
65 x 65 mm

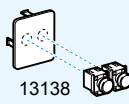

Buttons,
indicators light
22 mm diam.

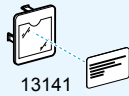

Identification
label

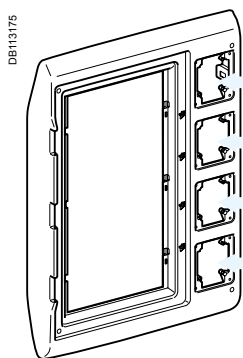

Enclosures for modular devices with interface and interfaces

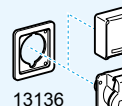

Domestic socket
65 x 85 mm



LV socket
65 x 85 mm

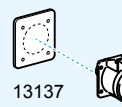

ELV sockets
65 x 65 mm



Identification
label

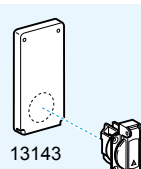

Domestic
socket
50 x 50 mm

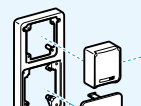

Domestic and
LV socket
65 x 85 mm



Buttons,
indicators light
22 mm diam.

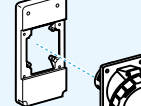

LV socket
90 x 100 mm

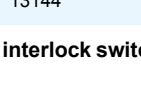

63 A LV socket
100 x 107 mm

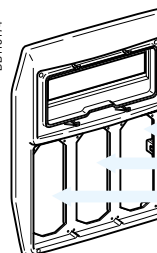

Enclosure for socket with interlock switch



Code for universal enclosures

Denomination	Description	Code
Plaque for opening		
Screw fixing	65 x 85	Blank - marked for 1 socket 50 x 50
	90 x 100	Blank - marked for 1 socket 65 x 65
Clip fixing		Blank - marked for button (1 or 2 x diam. 22.2 - 4 x diam. 16)
		With identification label
		Intermediate - with opening 65 x 85
Interface Kit for enclosures with interface		
Clip fixing	90 x 100	For switch INS 63/80A
		For modular devices 4P
Plaque for opening		
Screw fixing	103 x 225	Blank - marked for 1 socket 65 x 65 and for button (1 or 2 x diam. 22.2)
		With 1 opening 65 x 85 and 1 opening 90 x 100
		With 1 opening 100 x 107 for plugs and sockets 63 A

PB102284



Code of supports

These products are used to support the Kaedra enclosures in order to have them portable.

Each support is furnished with:

- 4 screws M6 x 14 to fix the enclosure
- 4 plain washer
- 4 elastic washer.

Dimensions			Description	Code
H	W	D	For enclosures of	
700	360	410	8 modules 13179-13186-13190	10500
700	450	410	12 modules 13181-13187-13192-13433-13180-13191-13195-13983	10501
700	560	410	18 modules 13182-13188-13193-13147-13991-13439-13984-13434	10502

Code of accessories for the installation

Denomination	Description	Code	
Mounting plate			
For non-modular devices	Telequick - h 150 mm width 12 modules	13941	
Inclined supports for terminal blocks for Mini-enclosures			
Flat bar 12 x 2 - clip fixing	Width 4 modules	13361	
	Width 6 modules	13362	
	Width 8 modules	13363	
	Width 12 modules	13364	
Inclined supports for terminal blocks for enclosures			
Flat bar 12 x 2 - screw fixing	Width 8 modules	13925	
	Width 12 modules	13597	
	Width 18 modules	13598	
Supports for terminal for enclosures bottom			
Flat bar 12 x 2 - screw fixing	Width 12 modules	13599	
	Width 18 modules	13595	
Terminal blocks 80 A (40°C)			
To be clipped on the support or on bottom by means of dove tile	Width 80 mm 4 hole (2 x 10 + 2 x 16)	13575	
To be clipped on the support or screw fixed on the bottom	Width 85 mm 8 hole (4 x 10 + 4 x 16)	13576	
	Width 202 mm 16 hole (8 x 10 + 8 x 16)	13577	
	Width 202 mm 22 hole (11 x 10 + 11 x 16)	13578	
	Width 202 mm 32 hole (16 x + 16 x 16)	13579	
Protective cover			
The cover is clipped on to the terminal block for insulation IP 2X degree of protection	Colour green	For blocks 4 hole	13581
		8 hole	13582
		12- 22 and 32 hole	13583
	Colour red	4 hole	13588
		8 hole	13584
		12- 22 and 32 hole	13585
	Colour blue	4 hole	13589
		8 hole	13586
		12- 22 and 32 hole	13587
	Collar for wiring		
	To organize wiring into the enclosures clip fixed on the bottom on the chassis	Set of 5	13946
	Accessories for enclosure maintenance		
Front plate	12 modules (250 x 150 x 25)	10200	
	18 modules (360 x 150 x 25)	10209	
Chassis 1 row	12 modules (280 x 130 x 35)	10210	
	18 modules (390 x 130 x 35)	10220	

PB102295



PB102296



Code of accessories for enclosures installation

Denomination	Description	Code	
Association kit M32			
	2 nipples + 2 nuts	13934	
Wall-mounting brackets kit			
To fixing enclosures to wall	Set of 4 for mini-enclosures for sockets	83929	
	Set of 4 for Kaedra enclosures	13935	
Separator set			
To separate 2 rail DIN zones	For enclosure width 12 modules	13936	
	For enclosure width 18 modules	13937	
Jack-up block			
		13938	
Sealing kit			
Prevent access to the live parts by sealing the base with the cover or the panels	4 kits	13947	
Key lock			
	Key	13948	
	Square	13950	
	Triangle	13949	
Blanking plates			
	Grey RAL 7035, set of 10 (5 modules)	13940	
Slotted plate			
	150 x 250 mm	13941	
Fear-lead			
	Pack	14190	
PG thread cable glands			
In accordance with DIN 46320 - Grey RAL 7035 - Complete with lock-nut	For cable		
	PG9	7 - 9 mm	83991
	PG11	9 - 11 mm	83992
	PG13.5	9 - 12 mm	83993
	PG16	10 - 13 mm	83994
	PG21	14 - 17 mm	83995
	PG29	16 - 26 mm	83996
	PG36	28 - 36 mm	83997
	PG42	30 - 38 mm	83998
	PG48	40 - 44 mm	83999



PG thread cable glands



Accessories for the finish of enclosures

Denomination	Description	Code
Symbol plate		
Ordinary	Set of 10	13735
Special		13736
Label support sheet		
To be printed by Sismarker	Set of 10	13260

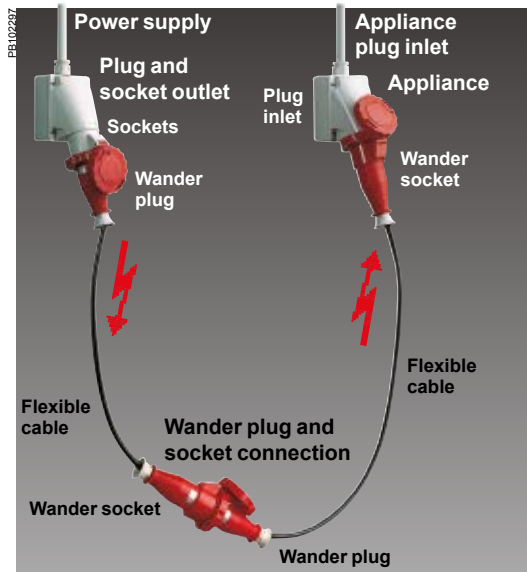

Wander plug and socket connection: device which permits the connection of two flexible cables: it comprises a wander socket and a plug.

Wander plug: part which is securely connected, or designed to be connected, to a power supply flexible cable.

Appliance plug inlet: device which permits the connection of a flexible cable to an appliance: it comprises a wander socket a plug inlet.

Plug inlet: incorporated part fixed, or designed to be fixed, to an appliance.

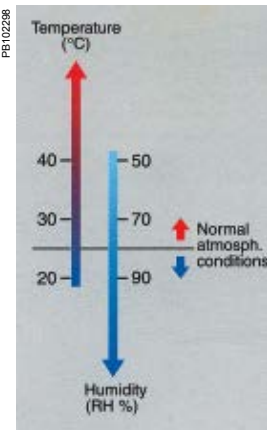

The normal pollution level is:
for domestic or similar devices: for industrial type applications:

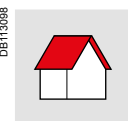

Level 2

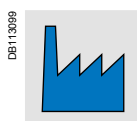

Level 3

The pollution level is a conventional number based on the amount of conductive or hygroscopic dust, ionised gas or salts, on the relative humidity and on the frequency which causes absorption or condensation of humidity, a phenomenon which involves a reduction of dielectric strength and/or surface resistivity. The pollution level referred to is the one occurring in the immediate vicinity to the air and surface between elements with different potential.

The products included in this catalogue can be used also in environments with particularly severe conditions. Contact us for any further information.

The catalogue includes a vast range of plugs and sockets designed mainly for industrial use, both indoor and outdoor, where the ambient temperature does not normally exceed 40°C. Thanks to the manufacturing characteristics and to the use of materials with superior performance and resistance to chemical and environmental agents, these devices are widely used also in building sites and in other sectors, like workshops, agriculture and offices. In the case of use in special environments, for example on ships, or in areas with explosion hazards, special characteristics can be required. In the case of use under severe conditions, it may be advisable to replace sockets with dirty and oxidated contacts, either periodically, or when the insertion or extraction force is considered too high.

Reference standards

The standards, from a point of view of dimensions and performance, for this family of products are defined at an international level and included in the European standards:

- IEC 60309-1
- IEC 60309-1-4
- EN 60309-1.

- Plugs and sockets for industrial use
- Part 1: General provisions.

- IEC 60309-2
- EN 60309-2.

- Plugs and sockets for industrial use
- Part 2: provisions of dimensional interchangeability for plugs and sockets with cylindrical pins and sleeves.

Definitions

The various applications of plugs and sockets include the following devices:

- **Plug and socket outlet:** device which permits the connection of a flexible cable to a power supply installation: it comprises a socket and a plug
- **Socket:** part which is to be installed in the power supply installation or incorporated in switchgear and controlgear
- **Plug:** part which is securely connected, or designed to be connected, to a flexible cable connected to an appliance or to a connector.

Operating conditions

The Standards IEC 60947-1, EN 60947-1, "Low-voltage switchgear and controlgear: general rules", define the normal operating conditions for electrical and electronic devices.

Such standards are generally applicable to devices operating within the voltage limit of up to 1,000 V for alternated current or 1,500 V for direct current, unless otherwise required by the specific product standard.

Ambient temperature

- Maximum temperature: +40°C with average temperature during 24 hours not exceeding +35°C.
- Lower temperature limit: -25°C.

Altitude

Up to 2,000 m a.s.l.

Atmospheric conditions

Humidity

- Relative humidity not exceeding 50% with temperature of +40°C.
- A higher relative humidity is allowed with a lower temperature, for example, 90% with +20°C (see drawing).

Level of environmental pollution

The following levels of pollution are considered for electrical and electronic devices:

Level 1

There is no pollution or there may be dry non-conductive pollution;

Level 2

Normally the devices can be used in the presence of non-conductive polluting substances, occasionally there may be temporary conductivity caused by condensation.

Level 3

Presence of conductive pollution or dry non-conductive pollution, which become conductive with condensation.

Level 4

The pollution causes persistent and high conductivity, such pollution is caused for example by conductive dust, rain or snow.

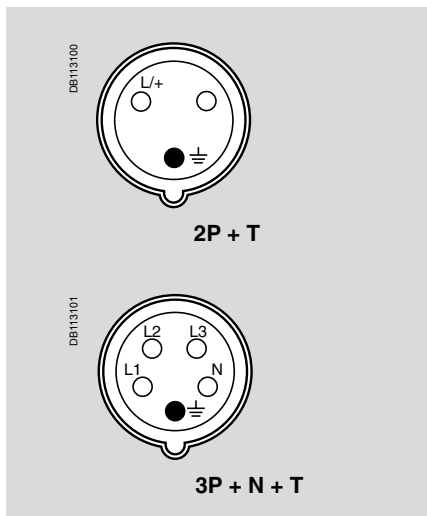

Low voltage socket

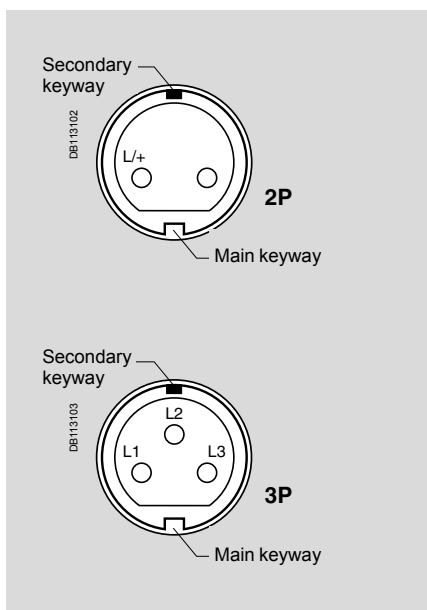

Extra-low voltage socket

Principal provisions

The standards cover the use of plugs and sockets with either alternate current, frequency of up to 500 Hz, or direct current, divided into two main classes:

- extra-low voltage plugs and sockets, with operating voltage of up to 50 V
- low voltage plugs and sockets, with operating voltage of 50 V to 690 V.

The standards cover rated currents of 16 and 32 A with 2P and 3P configurations for extra-low voltage, and rated currents of 16, 32, 63 and 125 A with 2P+ \perp , 3P+ \perp and 3P+N+ \perp for low voltage.

There is a specific model for each use, with different rated characteristics of voltage, frequency, polarity and application, incorporating safety hindrances which make it impossible to insert any plug in a socket which is not the exact corresponding type.

Non-interchangeability is ensured by compliance with the different standardised dimension tables which indicate different ground contact positions in relation to a standard fixed reference of the connection.

Low voltage versions > 50 V

In the low voltage versions non-interchangeability is ensured by means of two elements:

- a guide spline on the socket which matches with a corresponding nib on the plug
- a ground contact larger than the other contacts, in a different clock position according to the rated operating characteristics.

The clock position (h) of the ground contact is checked by observing, with the socket viewed from the front, the position of the ground contact in relation to the main keyway (guide spline), always positioned at 6 o'clock.

Extra-low voltage versions < 50 V

Also for these versions, with no ground contact, non-interchangeability is ensured by means of two reference elements:

- a guide spline on the plug which matches with a corresponding nib on the socket, always at a fixed 6 o'clock position
- a secondary keyway, also this a spline on the plug to which corresponds a nib on the socket, at different clock positions according to the operating characteristics.

The clock position (h) of the secondary keyway is checked by observing, with the socket viewed from the front, the position of the nib in relation to the main keyway, always positioned at 6 o'clock.

Coded colours

For easy identification of the operating voltage, the standard indicates conventional coded colours which may involve the entire device or only one part (e.g., lift cover, ring, etc.).

Rated operating voltage	Colour ⁽¹⁾
De 10 à 25 V	Violet
De 40 à 50 V	White
De 100 à 130 V	Yellow
De 200 à 250 V	Blue
De 380 à 480 V	Red
De 500 à 690 V	Black

(1): for a frequency above 60 Hz and up to 500 Hz included, the green colour can be used, if necessary, in conjunction with the colour of the rated operating voltage.

Clock reference

The range comprises all versions covered by the standards, including the more specific ones. Although the catalogue covers only some standard models, it is possible to have all the different clock positions specified by the standard; the following are some of the positions for this range:

Application	Clock position ground contact	
Common use	h 6	
Refrigerated containers	h 3	
Marines, wharf and ship installations	h 11	
Power supply through isol.transformer (TST)	h 12	
Direct current	50 to 250 V	h 3
	Above 250 V	h 8
High-frequency	100 to 300 Hz	h 10
	Above 300 to 500 Hz	h 2
Special voltage	100 to 130 V	h 4
	480 to 500 V	h 7
	600 to 690 V	h 5

Possible variations are indicated in the table at page 62.

The standard classifies and codifies a great number of external influences to which an electrical system may be subjected: presence of water, solid objects, risk of impacts, vibrations, presence of corrosive substances, etc.
 These situations can affect electrical components with a variable intensity depending on the characteristics of the system: presence of water, for example, can be either some drops of water falling or total immersion.

IP code

The standard IEC 60529 (EN 60529) indicates, by means of the IP code, the degree of protection for electrical devices against access to energised parts and against the entry of water and of foreign solid objects.

This standard does not consider the protection against the risk of explosion or environmental situations like humidity, corrosive vapours, moulds or insects.

The IP code is composed of 2 characteristic digits and can be expanded by an additional letter if the protection of people against access to energised parts is greater than the one indicated by the first digit.

Another supplementary letter indicates additional information on the protection of material.
 The table below indicates the classification criteria of the IP code.

Degree of protection IP in accordance to IEC 60529

1st characteristic digit: protection against the entry of foreign objects and against access to dangerous parts.

Meaning	0	1	2	3	4	5	6
Protection of the enclosure against the entry of		Solid objects with dimensions greater than 50 mm	Solid objects with dimensions greater than 12.5 mm	Solid objects with dimensions greater than 2.5 mm	Solid objects with dimensions greater than 1 mm	Harmful amount of dust Talcum powder	Dust (totally protected) Talcum powder

2nd characteristic digit: protection against the infiltration of water

Meaning	0	1	2	3	4	5	6	7	8	9
Protection of the enclosure against the harmful effect of		Water drops falling vertically	Water drops falling vertically with an angle of 15° from vertical	Rain	Splashes of water	Jets of water	Strong jets of water	Temporary immersion	Continuous immersion	Protected against close-range high pressure, high temperature spray downs

Optional letters

The additional letter is used only if the actual protection of persons is higher than that indicated by the first characteristics numeral of the IP code.

If only the protection of persons is of interest, the two characteristics numerals are replaced by the letter "X", e.g. IPXXB.

Additional letter	Protection
A	Protection of person against access with back of hand
B	Protection of person against access with finger
C	Protection of person against access with tool
D	Protection of person against access with wire

If only the protection of persons is of interest, the two characteristics numerals are replaced by the letter "X", e.g. IPXXB.

Supplementary letter*	Protection
H	High voltage devices
M	Tested against the harmful effects of water infiltration when the mobile parts of the device are moving
S	Tested against the harmful effects of water infiltration when the mobile parts of the device are not moving
W	Suitable for use in specified atmospheric conditions and provided with additional measures and procedures

(*) For the protection of material.

Used only if:

- the effective protection against access to dangerous parts is greater than the one indicated by the first characteristic digit
- only the protection against access to dangerous parts is indicated and the first characteristic digit is then replaced by an X.

Example of full application of the IP code

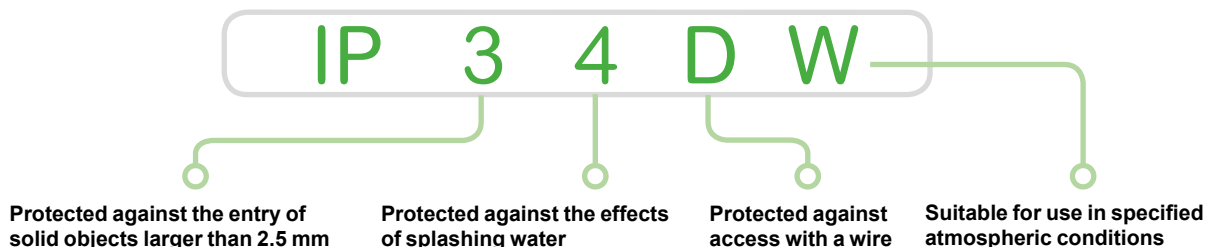

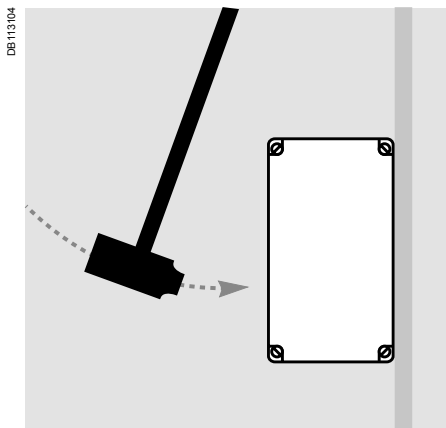

DE113104

Degree of protection against mechanical impacts IK

The standard EN 62262 defines the degree of protection against mechanical impacts indicated with the letters IK, followed by a number. The following table indicates the impact values in joules corresponding to each code.

Degree of protection against mechanical impacts IK in accordance with standard EN 62262

IK code	Impact energy
00	Not protected
01	0.15 Joule
02	0.2 Joule
03	0.35 Joule
04	0.5 Joule
05	0.7 Joule
06	1 Joule
07	2 Joule
08	5 Joule
09	10 Joule
10	20 Joule

Behaviour to abnormal heat and to fire

Self-extinguishing characteristics and behaviour to abnormal heat and to fire

The assessment index for the behaviour to fire of components made of organic material is defined by the different product standards and generally refer to three different test methods.

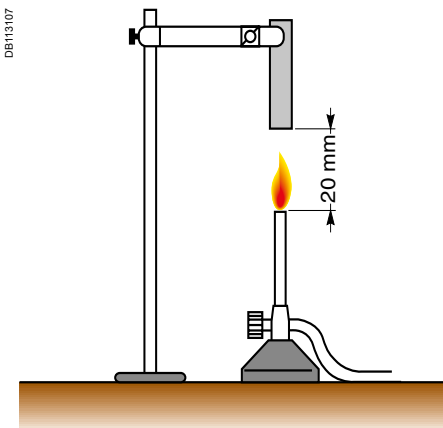
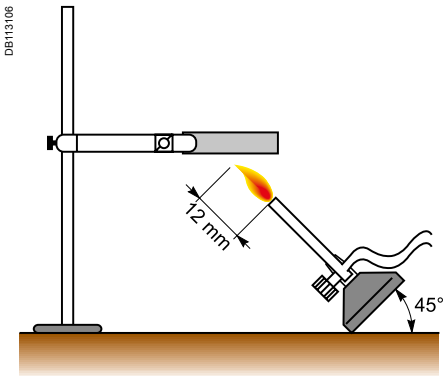
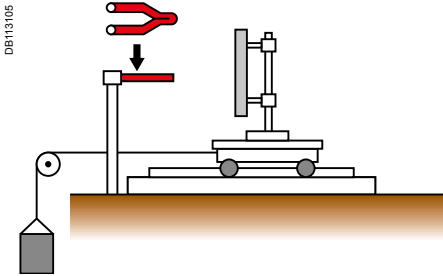

Aim of the tests	Tests results	Tests conditions
Glow-wire test in accordance with IEC 60695-2-11		
Simulate the thermal stress which may be produced by heat or ignition sources (incandescent elements or overloaded resistors for short periods) to be able to assess the danger of starting a fire.	Any flame must stop within 30 sec after removing the incandescent wire. <ul style="list-style-type: none"> ■ Test temperatures □ 650°C □ 750°C □ 850°C □ 960°C Falling burning drops do not set fire to the tissue paper.	Heat sources 4 mm diameter incandescent wire Duration of the test Wire applied for 30 sec. Characteristic elements Extinguishing time of the flame
Flame with needle test in accordance with IEC 60695-2-12		
Simulate the effect of small flames which may occur in a malfunction condition within the products with the aim of judge the risk of fire.	<ul style="list-style-type: none"> ■ The sample does not catch fire ■ The flame and the incandescent particles do not propagate fire ■ The duration of combustion is less than 30 sec after removing the Bunsen burner 	Heat sources Flame from a Bunsen burner Duration of the test Flame applied for 5, 10, 20, 30, 60, 120 sec according to the specific standard Characteristic elements The degree of severity: flame application time (AT)
UL method - Underwriters Laboratories in accordance with UL 94		
Supply a classification of the various behaviours which the materials may after contact with the flame from a Bunsen burner	<ul style="list-style-type: none"> ■ V0 if the specimen burns on average for less than 5 sec before self-extinguishing ■ V1 if it burns on average for less than 25 sec. ■ V2 if it burns for less than 25 sec with incandescent drips ■ HB if it burns for more than 25 sec (specimen horizontal and combustion velocity less than 38 mm/min) Assimilated to ASTM D-635	Heat sources Flame from a Bunsen burner Duration of the test Flame applied for 10 sec twice in a row Characteristic elements Duration of combustion







Behaviour to chemical agents

The indications stated below are applicable to the conditions where the ambient temperature does not exceed 40 °C and the mechanical stress is not so concentrated as to cause permanent surface deformations.

The engineering polymers used for our products ensure optimum behaviour of the finished products to chemical and atmospheric agents.

Should such products be used in environments with a particularly high concentration of acids, bases, oils, it will be advisable to contact our Technical Department for a better solution to the problem.

In any case, the series of products highlighted with blue are suitable for use in particularly aggressive environments, characterised by strong concentration of oils, bases and acids.

Product series	ACIDS		BASES		SOLVENTS			OIL			FUEL									
	H ₂ O	Saline solution	Conc.	Diluted	Conc.	Diluted	Hexane	Benzene	Acetone	Absol. ethyl alcohol	Silicone	Mineral	Veget. oil	Animal fat	Synthetic grease	Animal organic solution	Unleaded premium	Premium	Diesel	Ammonia
PratiKa low and extra-low voltage  Plugs and sockets	R	R	RL	R	RL	R	R	RL	RL	R	R	R	R	R	R	R	RL	RL	R	R
 Domestic sockets	R	R	RL	R	RL	R	R	RL	RL	R	R	R	R	R	R	R	RL	RL	R	R
 Schuko sockets	R	RL	RL	R	RL	R	R	NR	NR	R	R	NR	NR	NR	NR	NR	NR	NR	NR	NR
PratiKa Unika  Sockets with interlock switch	R	R	NR	R	RL	R	NR	NR	NR	NR	R	RL	RL	NR	RL	RL	NR	NR	NR	RL
 Modular bases	R	R	NR	R	RL	R	NR	NR	NR	NR	R	RL	RL	NR	RL	RL	NR	NR	NR	RL
PratiKa Isoblock  Sockets with interlock switch	R	R	RL	R	RL	R	R	RL	RL	R	R	R	R	R	R	R	RL	RL	R	R
 Modular panels	R	R	RL	R	RL	R	R	RL	RL	R	R	R	R	R	R	R	RL	RL	R	R
 Junction boxes	R	NR	RL	R	RL	R	R	NR	NR	R	R	RL	RL	NR	NR	RL	NR	NR	NR	NR
Kaedra system  Enclosures	R	R	RL	R	RL	R	NR	NR	NR	R	R	RL	RL	NR	RL	NR	NR	NR	NR	RL

Legend: ● R Resistant ● RL Limited resistance ● NR Not resistant

Summary table of identification and interchangeability

Summary table of identification and interchangeability for industrial-type plugs and sockets included in the different systems covered by the IEC 60309-2 and IEC 60309-4 standards

LOW VOLTAGE - above 50 V up to 690 V

2P+⊕				3P+⊕				3P+N+⊕								
FREQ. (Hz)	RATED VOLTAGE Un (V)	SOCKET'S FRONT VIEW OF EARTH CONTACT POSITION ⁽¹⁾			FREQ. (Hz)	RATED VOLTAGE Un (V)	SOCKET'S FRONT VIEW OF EARTH CONTACT POSITION ⁽¹⁾			FREQ. (Hz)	RATED VOLTAGE Un (V)	SOCKET'S FRONT VIEW OF EARTH CONTACT POSITION ⁽¹⁾				
		16 and 32 A	63 and 125 A				16 and 32 A	63 and 125 A				16 and 32 A	63 and 125 A			
50 and 60	100-130	4 h	4 h			100-130	4 h	4 h			57/100-75/130	4 h	4 h			
	200-250	6 h	6 h			200-250	9 h	9 h			120/208-144/250	9 h	9 h			
60	277	5 h	5 h		50 and 60	380-415	6 h	6 h		50 and 60	200/346-240-415	6 h	6 h			
50 and 60	380-415	9 h	9 h			480-500	7 h	7 h			277/480-288/500	7 h	7 h			
	480-500	7 h	7 h			600-690	5 h	5 h			347/600-400/690	5 h	5 h			
	Supply by isolating transformer	12 h	12 h		Supply by isolating transformer		12 h	12 h								
100-300 included	More than 50	-	-		60	440-460 ⁽²⁾	11 h	11 h		60	250/440-265/460	11 h	11 h			
301-500 included	More than 50	2 h	-		50 60	380-440 ⁽⁴⁾	3 h	-		50 60	220/380-250/440 ⁽⁴⁾	3 h	-			
DC	50-250 included	3 h	3 h		100-300 included	More than 50	10 h	-		100-300 included	More than 50	-	-			
	More than 250	8 h	8 h		301-500 included	More than 50	2 h	-		301-500 included	More than 50	2 h	-			
												For all other rated voltage and/or frequencies that are not included in the above configuration		1 h	1 h	

EXTRA-LOW VOLTAGE - UP TO 50 V

FREQ. (Hz)	RATED OPERATING VOLTAGE (V)	POSITION OF SECONDARY KEYWAY ⁽⁵⁾		
		16 and 32 A	2P	3P
50 and 60	20-25	Without keyway		
50 and 60	40-50	12 h		
100 to 200 included	20-25 and 40-50	4 h		
300		2 h		
400		3 h		
401 to 500 included		11 h		
Direct current	20-25 and 40-50	10 h		

NOTES

- (1) The ground contact position is in relation to the keyway. The table indicates only the values for series I (16 - 32 - 63 - 125 A); however the devices can also be used in accordance with the values of series II (20 - 30 - 60 - 100 A).
- (2) Mainly for installation on ships. The positions indicated by a dash (-) are not standardised.
- (3) Colour according to voltage.
- (4) For refrigerated containers only (standardised ISO).
- (5) The position of the secondary keyway is in relation to the main keyway.

PratiKa plugs and sockets

Low voltage

Wander plugs and sockets

Plugs IP44

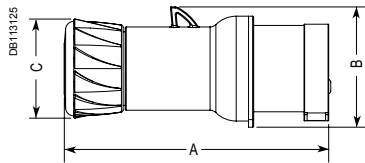

Dim.	16 A			32 A		
	2P+⊕	3P+⊕	3P+N+⊕	2P+⊕	3P+⊕	3P+N+⊕
A	129	139	142	152	152	160
B	59	65	74	76	76	86
C	48	48	58	58	58	58

IP67

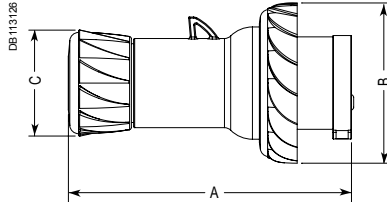

Dim.	16 A			32 A		
	2P+⊕	3P+⊕	3P+N+⊕	2P+⊕	3P+⊕	3P+N+⊕
A	129	139	142	152	152	160
B	73	81	89	95	95	102
C	48	48	58	58	58	58

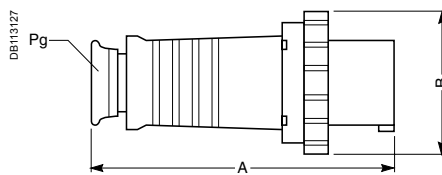

Dim.	63 A			125 A		
	2P+⊕	3P+⊕	3P+N+⊕	2P+⊕	3P+⊕	3P+N+⊕
A	265	265	265	325	325	325
B	110	110	110	131	131	131
Pg	36	36	36	48	48	48

Wander plugs angled 90°

IP44

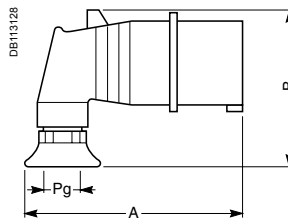

Dim.	16 A			32 A		
	2P+⊕	3P+⊕	3P+N+⊕	2P+⊕	3P+⊕	3P+N+⊕
A	110	115	119	141	141	141
B	91	98	105	113	113	116
Pg	16	16	16	21	21	21

IP67

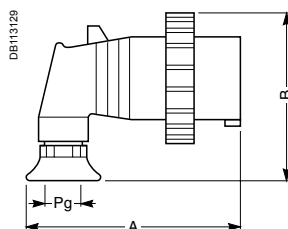

Dim.	16 A			32 A		
	2P+⊕	3P+⊕	3P+N+⊕	2P+⊕	3P+⊕	3P+N+⊕
A	110	115	119	141	141	141
B	91	98	105	113	113	116
Pg	16	16	16	21	21	21

Wander sockets

IP44

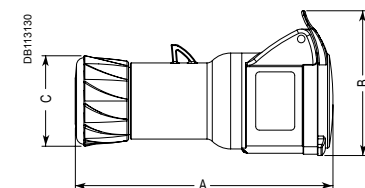

Dim.	16 A			32 A		
	2P+⊕	3P+⊕	3P+N+⊕	2P+⊕	3P+⊕	3P+N+⊕
A	140	150	153	165	165	172
B	78	88	97	98	98	106
C	48	48	58	58	58	58

IP67

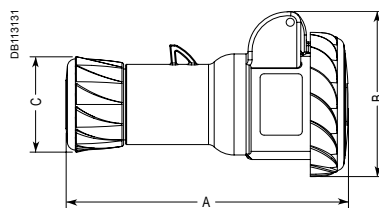

Dim.	16 A			32 A		
	2P+⊕	3P+⊕	3P+N+⊕	2P+⊕	3P+⊕	3P+N+⊕
A	142	152	155	164	164	173
B	84	87	96	99	99	104
C	48	48	58	58	58	58

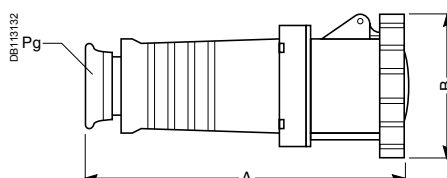

Dim.	63 A			125 A		
	2P+⊕	3P+⊕	3P+N+⊕	2P+⊕	3P+⊕	3P+N+⊕
A	265	265	265	325	325	325
B	110	110	110	131	131	131
Pg	36	36	36	48	48	48

Plugs with phase inverter

IP44

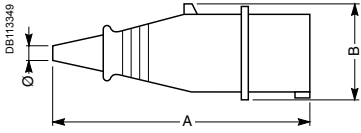

Dim.	16 A	
	3P+ \pm	3P+N+ \pm
A	145	163
B	66,5	74,5
Ø	10	13

IP67

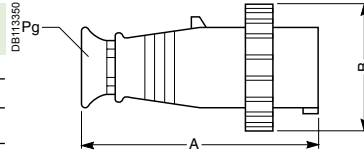

Dim.	16 A	
	3P+ \pm	3P+N+ \pm
A	139	147,5
B	77	87
Pg	Pg 16	Pg 21

Wander plugs angled 90° with phase inverter

IP44

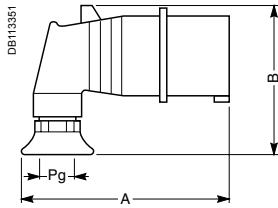

Dim.	16 A	
	3P+ \pm	3P+N+ \pm
A	115	119
B	91	98
Ø	16	16

IP67

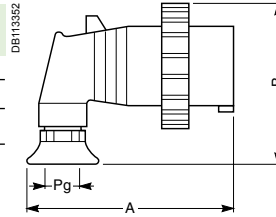

Dim.	16 A	
	3P+ \pm	3P+N+ \pm
A	115	119
B	98	105
Pg	16	16

Wall-mounted plugs with phase inverter

IP44

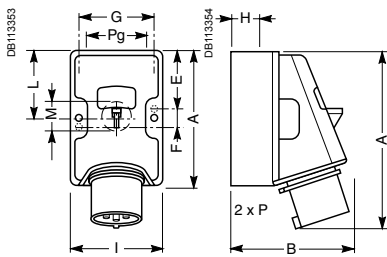

Dim.	16 A	
	3P+ \pm	3P+N+ \pm
A	100	130
B	109	125
C	140	134
E	41	7
F	18	116
G	67	92
H	21	25
I	80	106
L	50	65
M	23	28,5
Pg	21	21
P	2 x 16	2 x 21

IP67

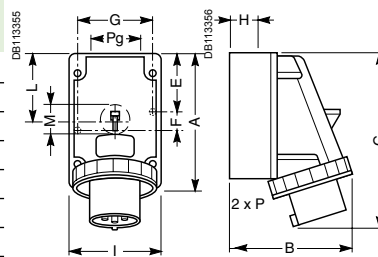

Dim.	16 A	
	3P+ \pm	3P+N+ \pm
A	100	130
B	116	169
C	140	134
E	41	7
F	18	116
G	67	92
H	21	25
I	80	106
L	50	65
M	23	28,5
Pg	21	21
P	2 x 16	2 x 21

Panel-mounted plugs with phase inverter

IP44

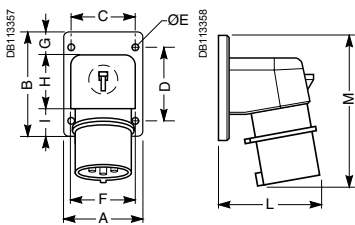

Dim.	16 A	
	3P+ \pm	3P+N+ \pm
A	65	90
B	85	100
C	52	77
D	60	85
E	5,2	5,5
F	53	76
G	20	20
H	41,5	59,5
I	23,5	20,5
L	85	96
M	124	148

IP67

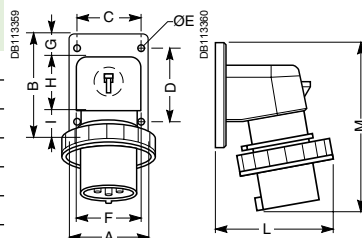

Dim.	16 A	
	3P+ \pm	3P+N+ \pm
A	65	90
B	85	100
C	52	77
D	60	85
E	5,2	5,5
F	53	76
G	20	20
H	41,5	59,5
I	23,5	20,5
L	92	107
M	124	148

System adapters

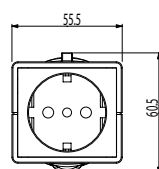
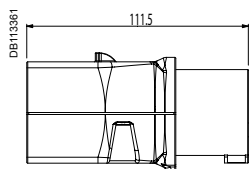

Domestic panel mounted sockets

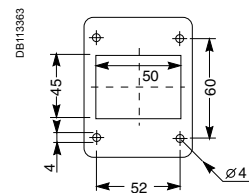
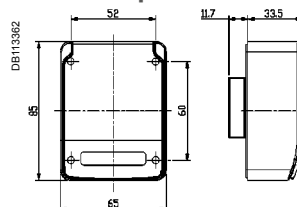

PratiKa plugs and sockets

Low voltage

Wall-mounted plugs

Wall-mounted plugs

IP44

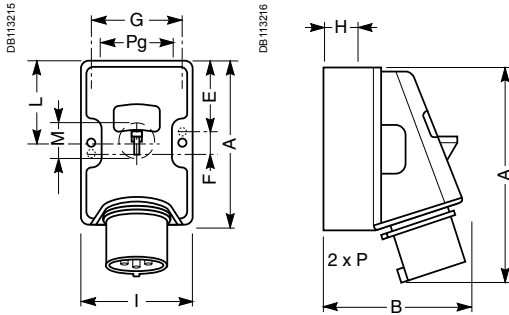

Dim.	16 A			32 A		
	2P+⊕	3P+⊕	3P+N+⊕	2P+⊕	3P+⊕	3P+N+⊕
A	100	100	130	130	130	130
B	106	109	125	130	130	132
C	139	140	134	136	136	140
E	41	41	7	7	7	7
F	18	18	116	116	116	116
G	67	67	92	92	92	92
H	21	21	25	25	25	25
I	80	80	106	106	106	106
L	50	50	65	65	65	65
M	23	23	28,5	28,5	28,5	28,5
Pg	21	21	21	21	21	21
P	2 x 16	2 x 16	2 x 21	2 x 21	2 x 21	2 x 21

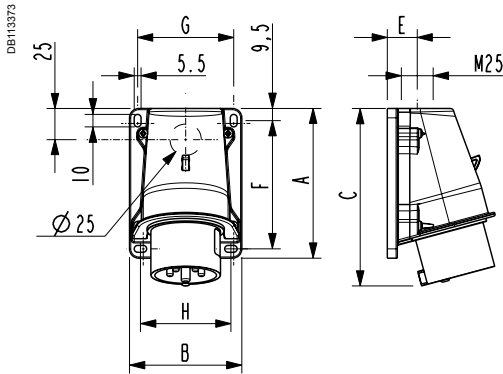

Dim.	16 A			32 A		
	2P+⊕	3P+⊕	3P+N+⊕	2P+⊕	3P+⊕	3P+N+⊕
A	100	100	120	120	120	120
B	75	75	90	90	90	90
C	122	123	142	151	151	152
D	76	76	86	89	89	95
E	21	21	24	24	24	24
F	83	83	103	103	103	103
G	62	62	77	77	77	77
H	57,5	57,5	72,5	72,5	72,5	72,5

IP67

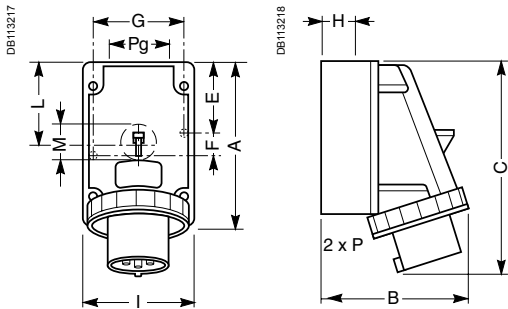

Dim.	16 A			32 A		
	2P+⊕	3P+⊕	3P+N+⊕	2P+⊕	3P+⊕	3P+N+⊕
A	100	100	130	130	130	130
B	111	116	169	178	178	179
C	139	140	134	136	136	140
E	41	41	7	7	7	7
F	18	18	116	116	116	116
G	67	67	92	92	92	92
H	21	21	25	25	25	25
I	80	80	106	106	106	106
L	50	50	65	65	65	65
M	23	23	28,5	28,5	28,5	28,5
Pg	21	21	21	21	21	21
P	2 x 16	2 x 16	2 x 16	2 x 16	2 x 16	2 x 16

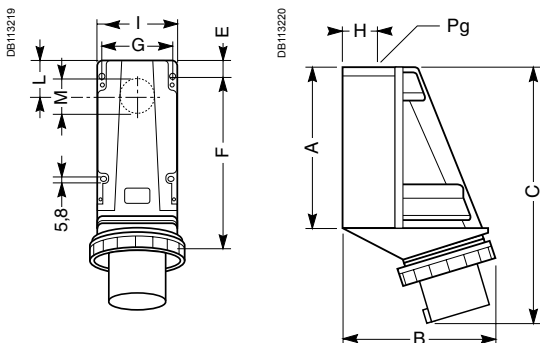

Dim.	63 A			125 A		
	2P+⊕	3P+⊕	3P+N+⊕	2P+⊕	3P+⊕	3P+N+⊕
A	162	162	162	224	224	224
B	180	180	180	214	214	214
C	281	281	281	354	354	354
E	8	8	8	23	23	23
F	127	127	127	147	147	147
G	88	88	88	97	97	97
H	31	31	31	44	44	44
I	104	104	104	114	114	114
L	40	40	40	50	50	50
M	38	38	38	60	60	60
Pg	29	29	29	48	48	48

Panel-mounted plugs

IP44

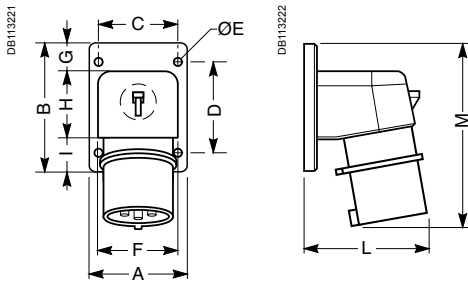

IP67

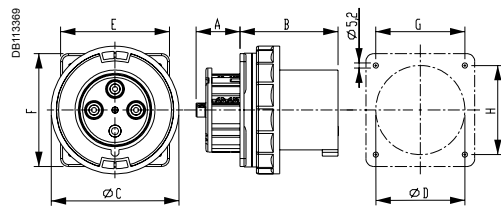
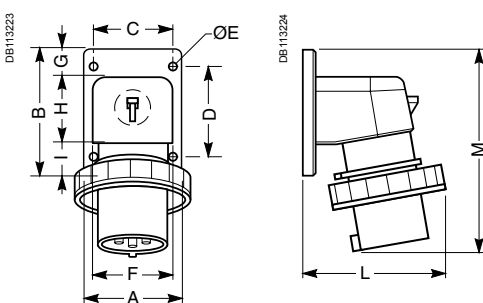

Retaining means for IP67 panel mounted - plugs of 63 A and 125 A (according to standards IEC 60309-2 and IEC 60309-4)

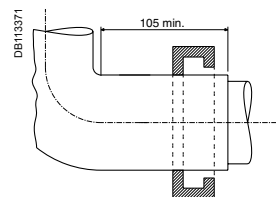

Small wall-mounted sockets

IP44

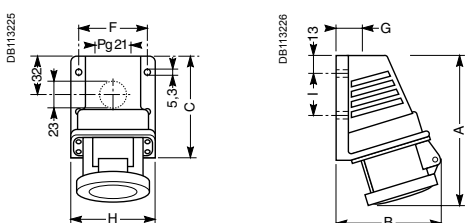

IP67

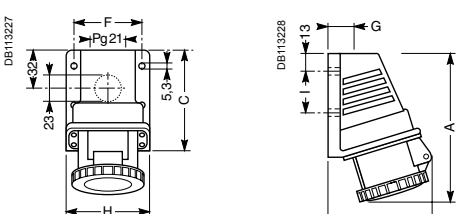

Dim.	16 A			32 A		
	2P+⊕	3P+⊕	3P+N+⊕	2P+⊕	3P+⊕	3P+N+⊕
A	65	65	90	90	90	90
B	85	85	100	100	100	100
C	52	52	77	77	77	77
D	60	60	85	85	85	85
E	5,2	5,2	5,5	5,5	5,5	5,5
F	53	53	76	76	76	76
G	20	20	20	20	20	20
H	41,5	41,5	59,5	59,5	59,5	59,5
I	23,5	23,5	20,5	20,5	20,5	20,5
L	82	85	96	98	98	101
M	123	124	148	159	159	159

Dim.	16 A			32 A		
	2P+⊕	3P+⊕	3P+N+⊕	2P+⊕	3P+⊕	3P+N+⊕
A	65	65	90	90	90	90
B	85	85	100	100	100	100
C	52	52	77	77	77	77
D	60	60	85	85	85	85
E	5,2	5,2	5,5	5,5	5,5	5,5
F	53	53	76	76	76	76
G	20	20	20	20	20	20
H	41,5	41,5	59,5	59,5	59,5	59,5
I	23,5	23,5	20,5	20,5	20,5	20,5
L	92	92	107	112	112	115
M	123	124	148	159	159	159

Dim.	63 A			125 A		
	2P+⊕	3P+⊕	3P+N+⊕	2P+⊕	3P+⊕	3P+N+⊕
A	24	24	24	44,5	44,5	44,5
B	89	89	89	99	99	99
C	114	114	114	129	129	129
D	75	75	75	90	90	90
E	100	100	100	110	110	110
F	107	107	107	114	114	114
G	77	77	77	90	90	90
H	85	85	85	90	90	90

PratiKa plugs and sockets

Low voltage

Wall-mounted sockets

Wall-mounted sockets

IP44

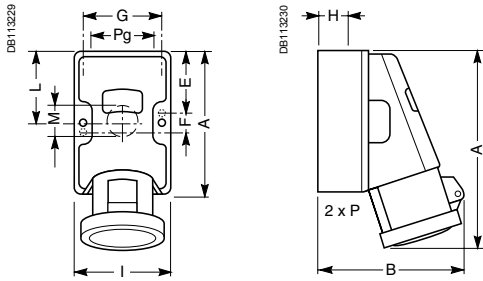

Dim.	16 A			32 A		
	2P+⊕	3P+⊕	3P+N+⊕	2P+⊕	3P+⊕	3P+N+⊕
A	100	100	130	130	130	130
B	126	126	141	145	145	149
C	154	155	176	189	189	192
E	41	41	7	7	7	7
F	18	18	116	116	116	116
G	67	67	92	92	92	92
H	21	21	25	25	25	25
I	80	80	106	106	106	106
L	50	50	65	65	65	65
M	23	23	28,5	28,5	28,5	28,5
Pg	21	21	21	21	21	21
P	2 x 16	2 x 16	2 x 21	2 x 21	2 x 21	2 x 21

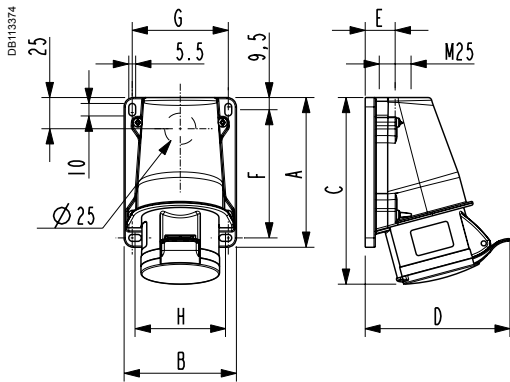

Dim.	16 A			32 A		
	2P+⊕	3P+⊕	3P+N+⊕	2P+⊕	3P+⊕	3P+N+⊕
A	100	100	120	120	120	120
B	75	75	90	90	90	90
C	129	131	150	160	160	160
D	100	104	116	119	119	125
E	21	21	24	24	24	24
F	83	83	103	103	103	103
G	62	62	77	77	77	77
H	57,5	57,5	72,5	72,5	72,5	72,5

IP67

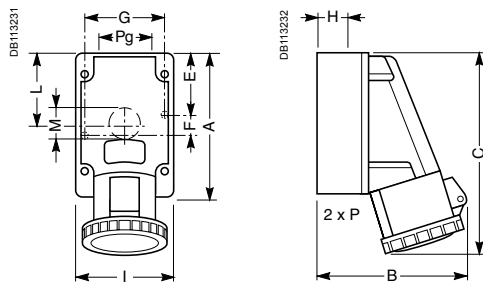

Dim.	16 A			32 A		
	2P+⊕	3P+⊕	3P+N+⊕	2P+⊕	3P+⊕	3P+N+⊕
A	100	100	130	130	130	130
B	126	127	143	148	148	154
C	155	156	178	191	191	194
E	41	41	7	7	7	7
F	18	18	116	116	116	116
G	67	67	92	92	92	92
H	21	21	25	25	25	25
I	80	80	106	106	106	106
L	50	50	65	65	65	65
M	23	23	28,5	28,5	28,5	28,5
Pg	21	21	21	21	21	21
P	2 x 16	2 x 16	2 x 21	2 x 21	2 x 21	2 x 21

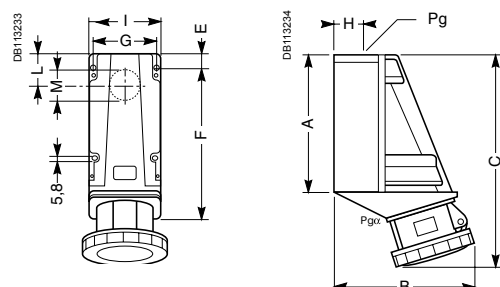

Dim.	63 A			125 A		
	2P+⊕	3P+⊕	3P+N+⊕	2P+⊕	3P+⊕	3P+N+⊕
A	162	162	162	224	224	224
B	180	180	180	213	213	213
C	255	255	255	340	340	340
E	8	8	8	23	23	23
F	127	127	127	147	147	147
G	88	88	88	97	97	97
H	31	31	31	44	44	44
I	104	104	104	114	114	114
L	40	40	40	50	50	50
M	38	38	38	60	60	60
Pg	29	29	29	48	48	48
Pgα	29	29	29	29	36	29

Straight panel-mounted sockets

IP44

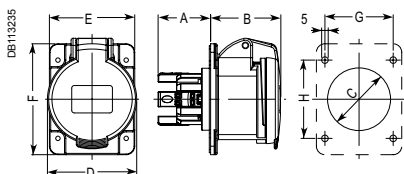

Dim.	16 A			32 A		
	2P+±	3P+±	3P+N+±	2P+±	3P+±	3P+N+±
A	40	40	40	42	42	42
B	54	54	54	63	63	64
C	44	48	55	58	58	65
D	60	68	76	82	82	89
E	65	65	90	90	90	90
F	85	85	100	100	100	100
G	52	52	77	77	77	77
H	60	60	85	85	85	85

IP67

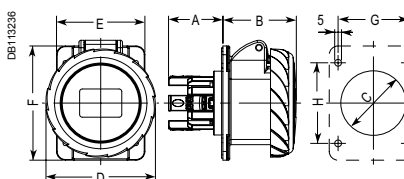

Dim.	16 A			32 A		
	2P+±	3P+±	3P+N+±	2P+±	3P+±	3P+N+±
A	40	40	40	42	42	42
B	54	54	54	63	63	64
C	44	48	55	58	58	65
D	73	81	89	95	95	102
E	65	65	90	90	90	90
F	85	85	100	100	100	100
G	52	52	77	77	77	77
H	60	60	85	85	85	85

Angled panel-mounted sockets

IP44

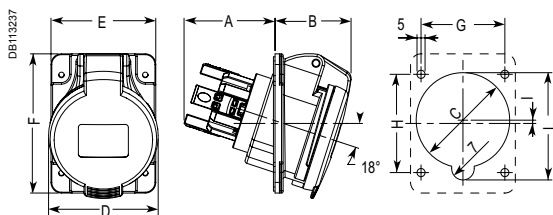

Dim.	16 A			32 A		
	2P+±	3P+±	3P+N+±	2P+±	3P+±	3P+N+±
A	57	57	56	64	64	64
B	46	48	50	53	53	55
C	54	58	70	70	70	75
D	60	68	76	82	82	89
E	65	65	90	90	90	90
F	85	85	100	100	100	100
G	52	52	77	77	77	77
H	60	60	85	85	85	85
I	2	2	7	3	3	2,5
L	59	65,5	75	76	76	83

IP67

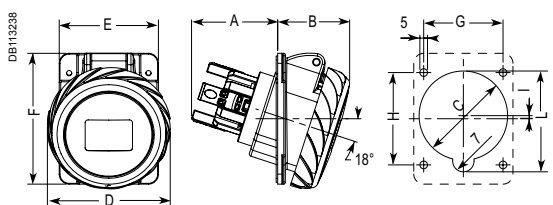

Dim.	16 A			32 A		
	2P+±	3P+±	3P+N+±	2P+±	3P+±	3P+N+±
A	57	57	56	64	64	64
B	46	48	50	54	54	57
C	54	58	70	70	70	75
D	73	81	89	95	95	102
E	65	65	90	90	90	90
F	85	85	100	100	100	100
G	52	52	77	77	77	77
H	60	60	85	85	85	85
I	2	2	7	3	3	2,5
L	59	65,5	75	76	76	83

Back box

Flanged 65x85

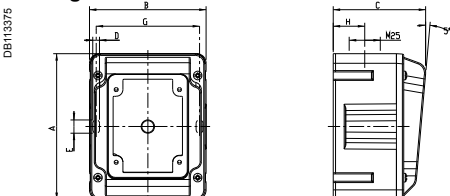

Dim.	Suitable for fitting socket with flange	
	65 x 85	90 x 100
A	120	155
B	96	102
C	76	89
D	5,5	5,5
E	11	11
F	-	125
G	85	90
H	26	26

Flanged 90x100

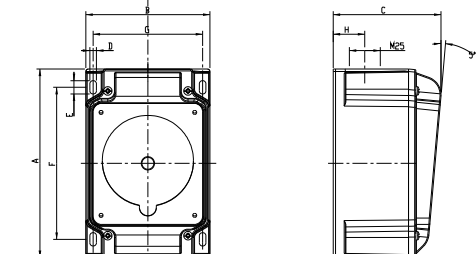

PratiKa plugs and sockets

Low voltage

Panel-mounted sockets

Straight panel-mounted sockets

IP44

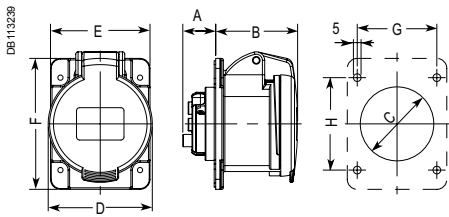

Dim.	16 A			32 A		
	2P±	3P±	3P+N±	2P±	3P±	3P+N±
A	22	22	22	28	28	28
B	54	54	54	63	63	64
C	44	48	54	58	58	65
D	60	68	76	82	82	89
E	65	65	90	90	90	90
F	85	85	100	100	100	100
G	52	52	77	77	77	77
H	60	60	85	85	85	85

IP67

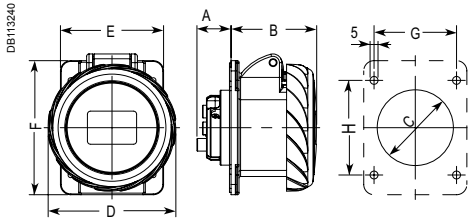

Dim.	16 A			32 A		
	2P±	3P±	3P+N±	2P±	3P±	3P+N±
A	22	22	22	28	28	28
B	54	54	54	63	63	64
C	44	48	54	58	58	65
D	73	81	89	95	95	102
E	65	65	90	90	90	90
F	85	85	100	100	100	100
G	52	52	77	77	77	77
H	60	60	85	85	85	85

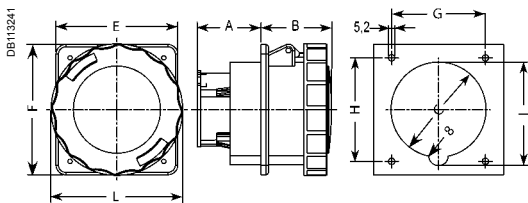

Dim.	63 A			125 A		
	2P±	3P±	3P+N±	2P±	3P±	3P+N±
A	52	52	52	76	76	76
B	61	61	61	85	85	85
C	78	78	78	90	90	90
E	100	100	100	110	110	110
F	107	107	107	114	114	114
G	77	77	77	90	90	90
H	85	85	85	90	90	90
I	85	85	85	96	96	96

L = 108 mm for 63 A and 129 mm for 125 A

Angled panel-mounted sockets

IP44

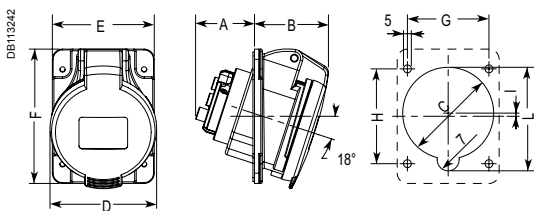

Dim.	16 A			32 A		
	2P±	3P±	3P+N±	2P±	3P±	3P+N±
A	38	38	37	48	48	48
B	46	48	50	53	53	55
C	54	58	70	70	70	75
D	60	68	76	82	82	89
E	65	65	90	90	90	90
F	85	85	100	100	100	100
G	52	52	77	77	77	77
H	60	60	85	85	85	85
I	2	2	7	3	3	2,5
L	59	65,5	75	76	76	83

IP67

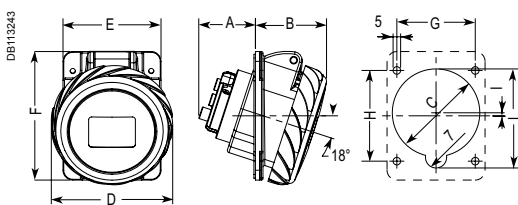

Dim.	16 A			32 A		
	2P±	3P±	3P+N±	2P±	3P±	3P+N±
A	38	38	37	48	48	48
B	46	48	50	54	54	57
C	54	58	70	70	70	75
D	73	81	89	95	95	102
E	65	65	90	90	90	90
F	85	85	100	100	100	100
G	52	52	77	77	77	77
H	60	60	85	85	85	85
I	2	2	7	3	3	2,5
L	59	65,5	75	76	76	83

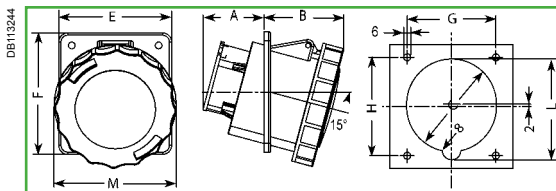

Dim.	63 A			125 A		
	2P±	3P±	3P+N±	2P±	3P±	3P+N±
A	56	56	56	76	76	76
B	73	73	73	90	90	90
C	82	82	82	96	96	96
E	100	100	100	110	110	110
F	107	107	107	114	114	114
G	77	77	77	90	90	90
H	85	85	85	90	90	90
I	90	90	90	102	102	102

M = 108 mm for 63 A and 129 mm for 125 A

PratiKa plugs and sockets

Extra-low voltage

Wander-plugs

IP44

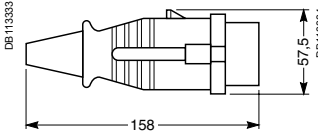

IP67

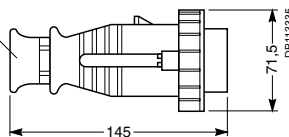

Wander sockets

IP44

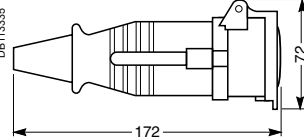

IP67

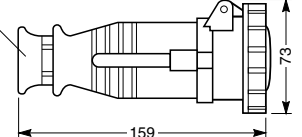

Wall-mounted plugs

IP44

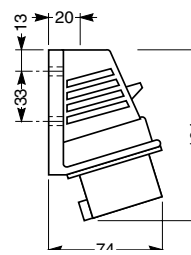
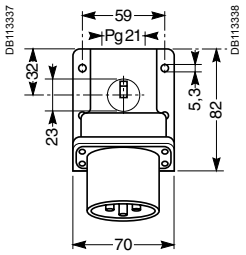

Wall-mounted sockets

IP44

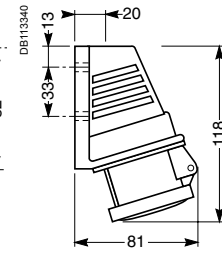
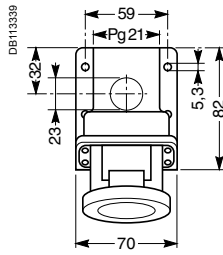

IP67

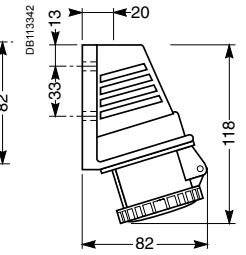
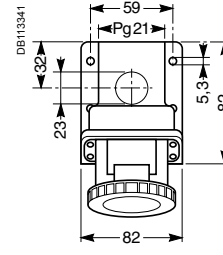

Multiple adapters 3 socket outlets

IP44

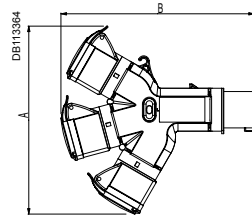

IP67

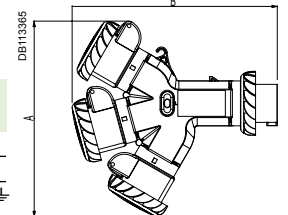

PLUG SIDE	IP44		SOCKET SIDE
	A	B	
16 A 2P+±	223	230	3 x 16 A 2P+±
16 A 3P+±	245	241	3 x 16 A 3P+±
32 A 3P+N+±	252	270	1x 32 A 3P+N+± +2 x 16 A 2P+±

PLUG SIDE	IP67		SOCKET SIDE
	A	B	
16 A 2P+±	222	233	3 x 16 A 2P+±
16 A 3P+±	242	244	3 x 16 A 3P+±
32 A 3P+N+±	251	274	1x 32 A 3P+N+± +2 x 16 A 2P+±

Multiple adapters 2 socket outlets

IP44

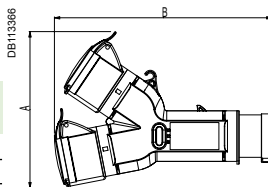

IP67

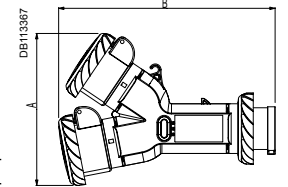

PLUG SIDE	IP44		SOCKET SIDE
	A	B	
16A 2P+±	160	230	2 x 16A 2P+±
16A 3P+±	173	241	2 x 16A 3P+±

PLUG SIDE	IP67		SOCKET SIDE
	A	B	
16A 2P+±	160	233	2 x 16A 2P+±
16A 3P+±	171	244	2 x 16A 3P+±

Panel-mounted straight sockets with flange 65 x 65

IP44

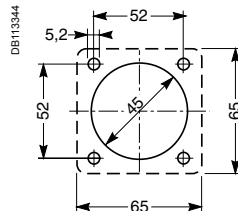
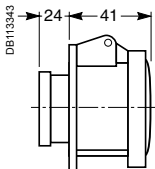

IP67

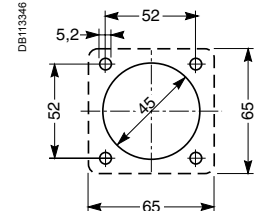
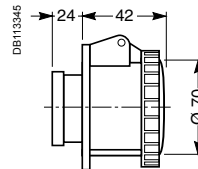

Domestic sockets 50 x 50

IP54

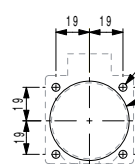
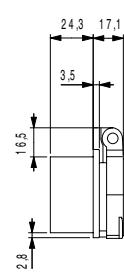
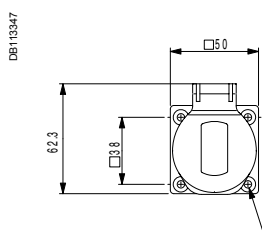

Domestic sockets 65 x 85

IP54

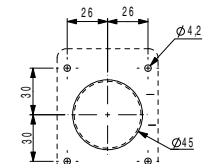
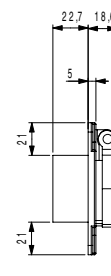
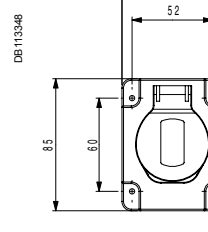

PratiKa sockets with interlock switch

Unika

Unika sockets with interlock switch

Wall-mounted version

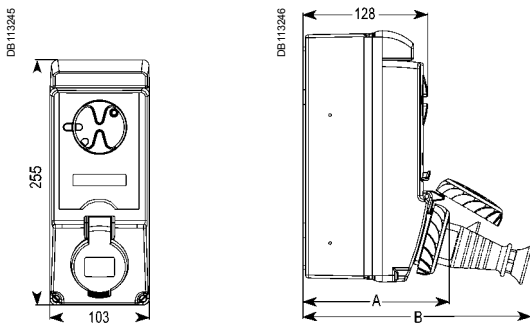

Panel-mounted version

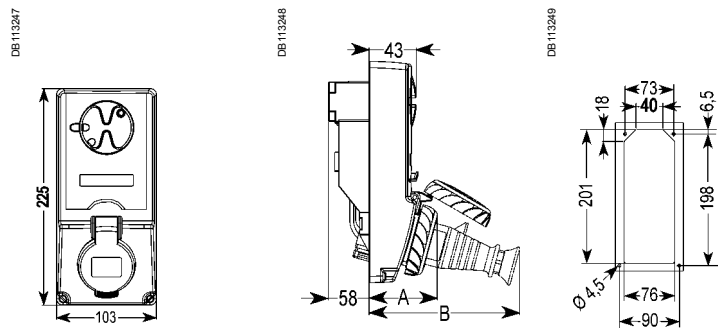

Dim.	IP44			IP65			IP44			IP65			IP44			IP65								
	3P	4P	5P	3P	4P	5P	3P	4P	5P	3P	4P	5P	3P	4P	5P	3P	4P	5P						
A	150	150	151	151	151	152	149	150	151	151	151	153	69	69	70	70	70	71	68	69	70	70	70	72
B	235	239	257	271	271	274	237	240	244	260	260	261	154	158	176	190	190	193	156	159	163	179	179	180

Unika sockets with safety transformer

Wall-mounted version

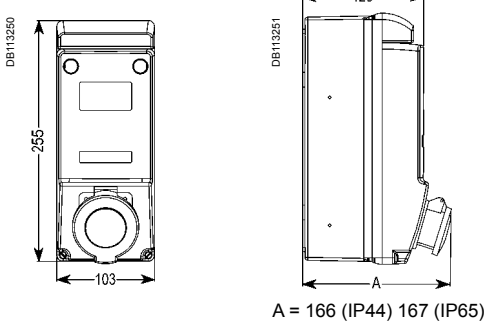

Panel-mounted version

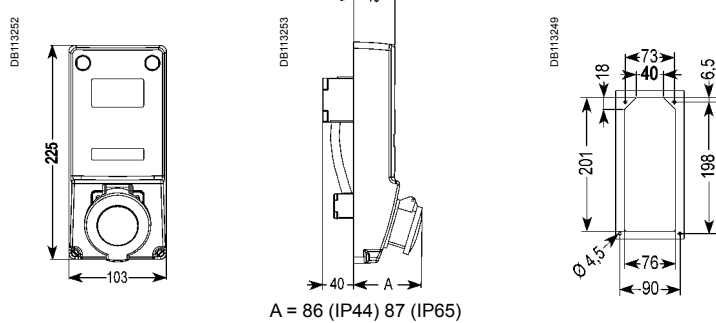

Unika sockets with safety transformer

Wall-mounting

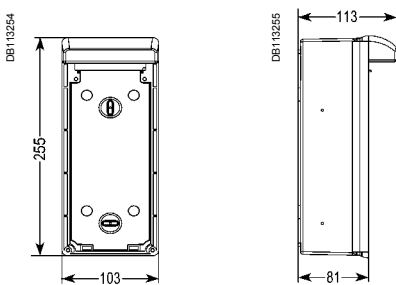

Embedded boxes

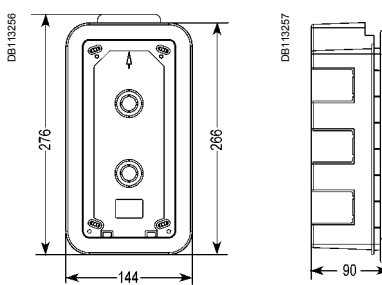

Unika Modular bases

Wall-mounting

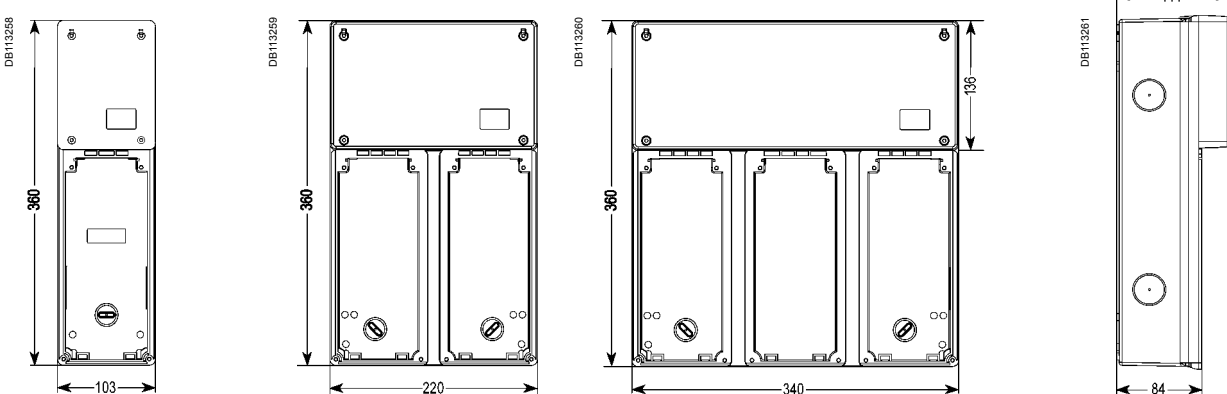

PratiKa sockets with interlock switch

Unika

Unika Sockets with interlock switch

Wall-mounted IP 65

Without protection

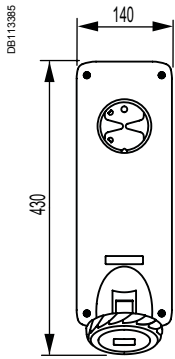

With DIN rail

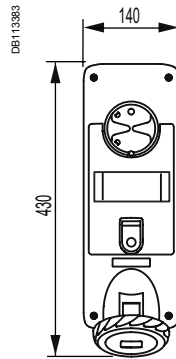

Protected by fuse carrier

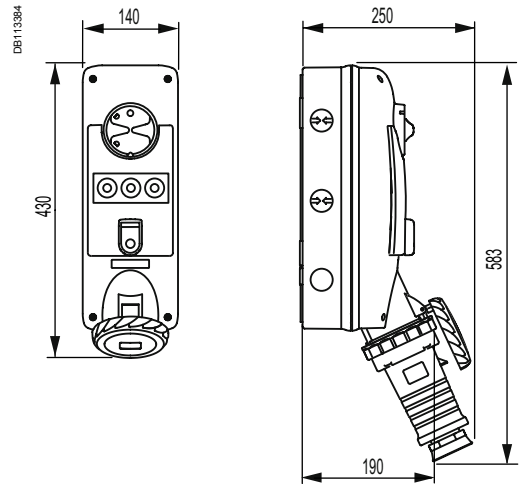

Panel-mounted IP 65

Without protection

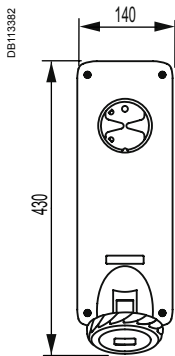

With DIN rail

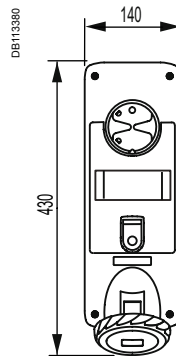

Protected by fuse carrier

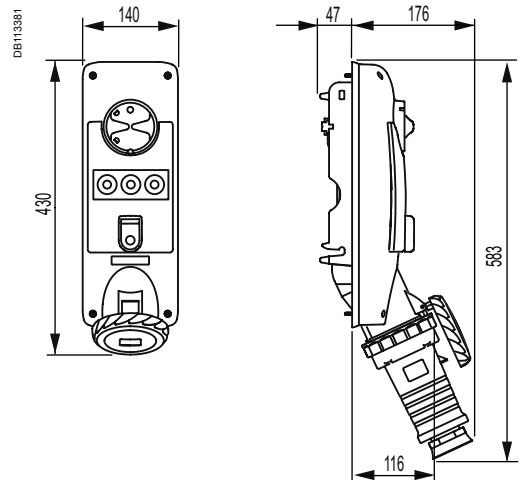

Fixing opening for panel-mounted version

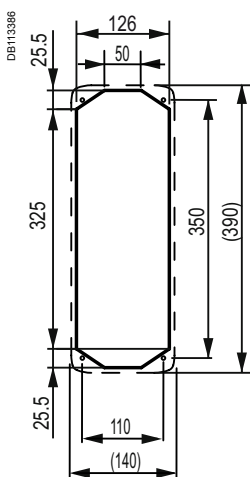

PratiKa sockets with interlock switch Isoblock

Isoblock - Sockets with interlock switch protected by disconnect fuse carriers with and without warning device

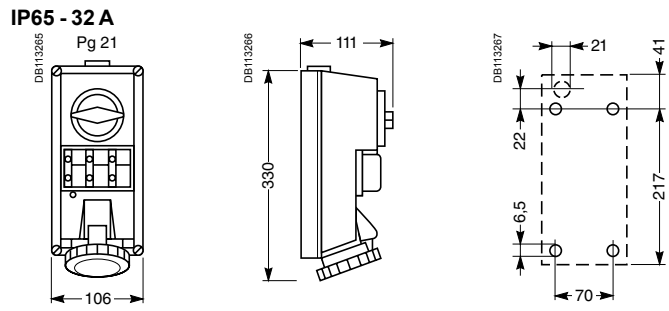
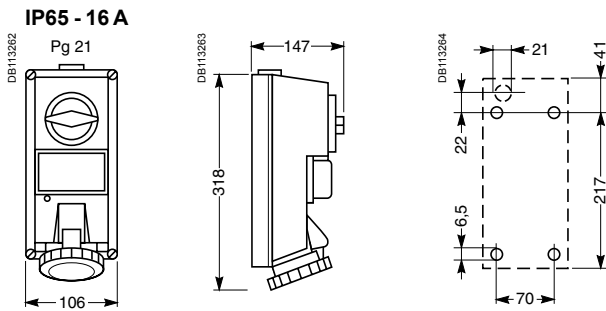

Sockets with interlock switch protected by diazed fuse carriers

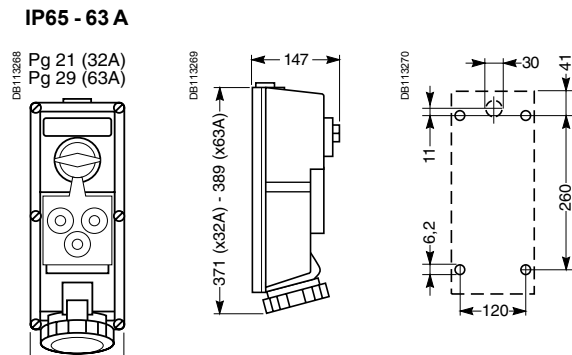

Sockets with safety transformer

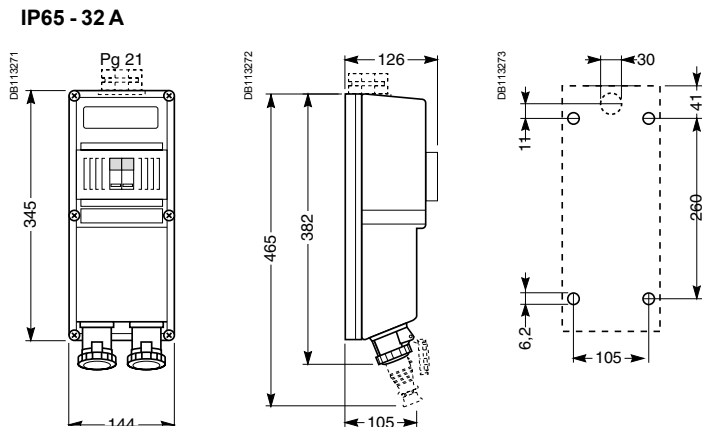

Sockets with DIN rail

IP65 - 16 A et 32 A

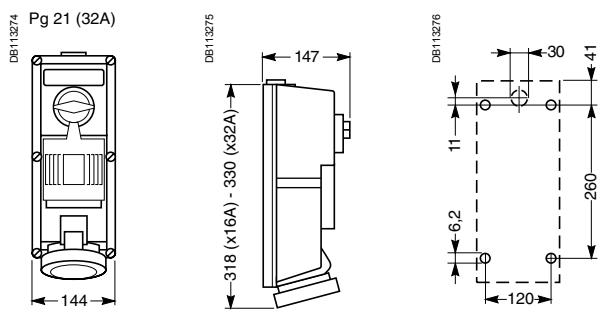

IP65 - 32 A et 63 A

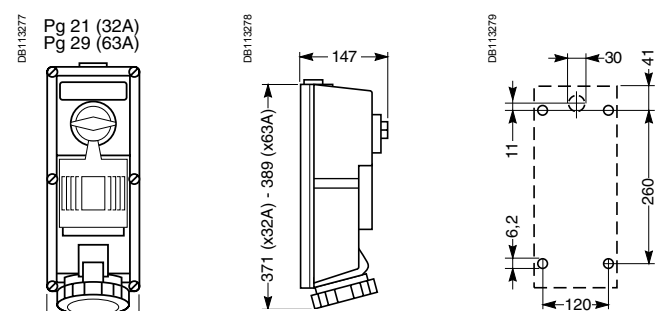

Modular panels

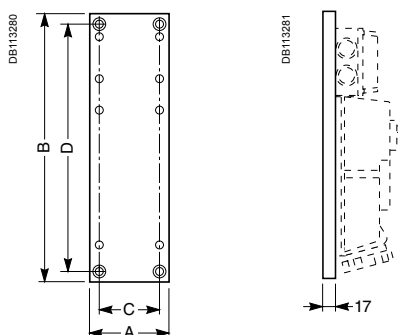

Dim.	83925 - 83325	83926 - 83326	83927 - 83327
A	111	222	151
B	535	535	535
C	81	192	121
D	514	514	514

Isoblock - Sockets with safety switch and electrical interlock

IP65 - 63 A et 125 A

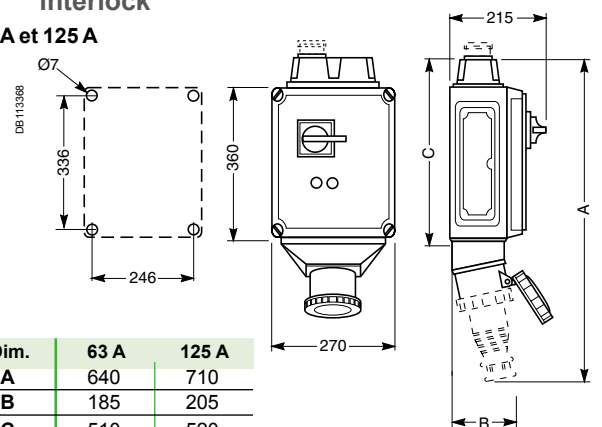

Dim.	63 A	125 A
A	640	710
B	185	205
C	510	520

Kaedra System

Enclosures for sockets

Mini enclosures for PratiKa sockets with holes 65 x 85

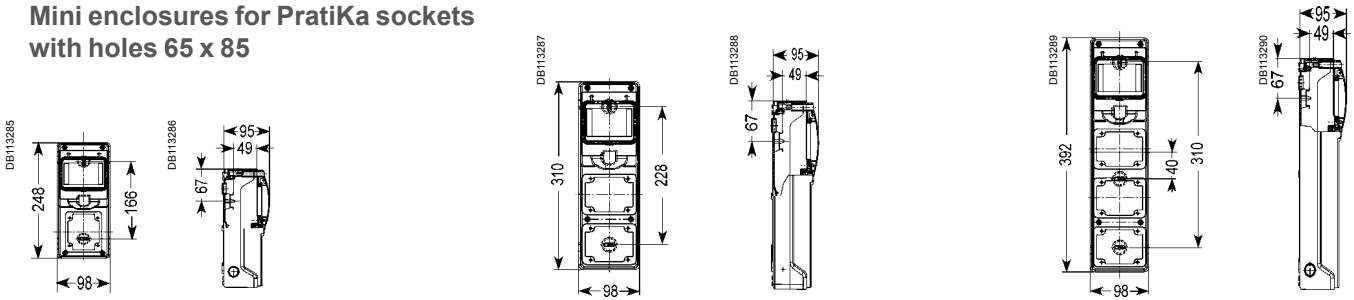

Enclosures for PratiKa sockets with holes 90 x 100

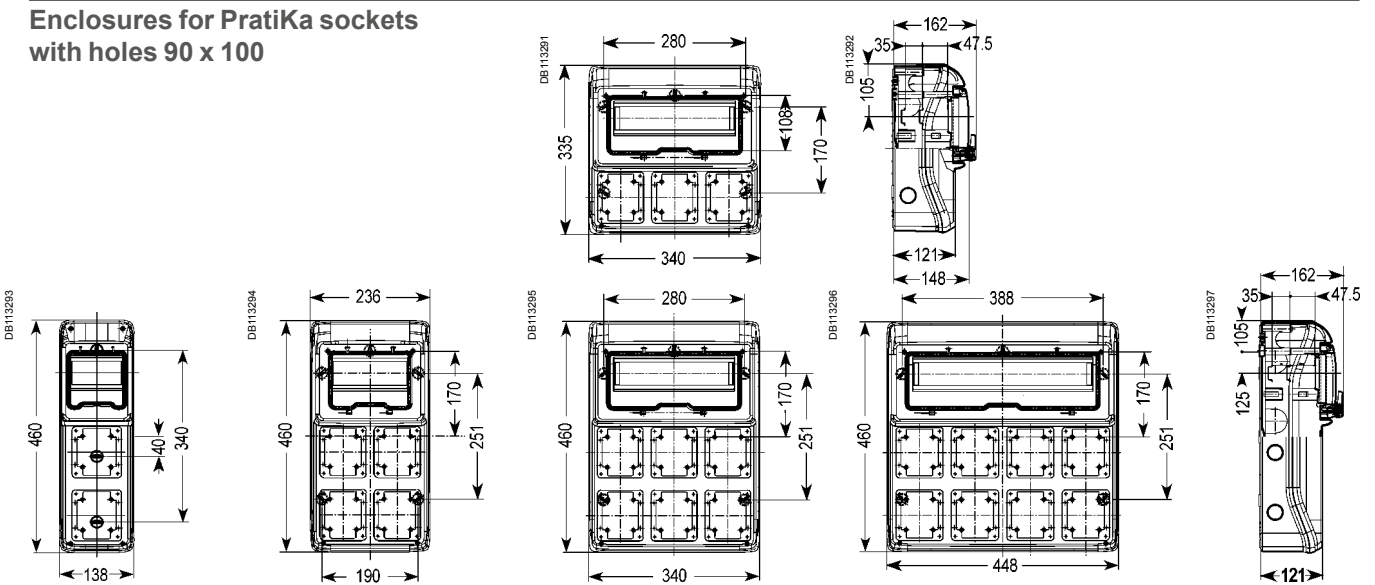

Enclosures for Unika sockets with holes 103 x 225

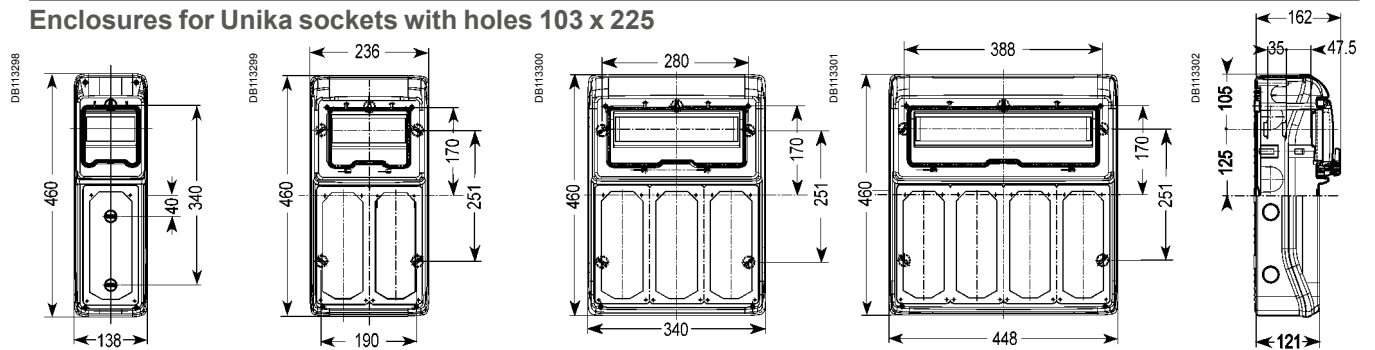

Enclosures for sockets combinations

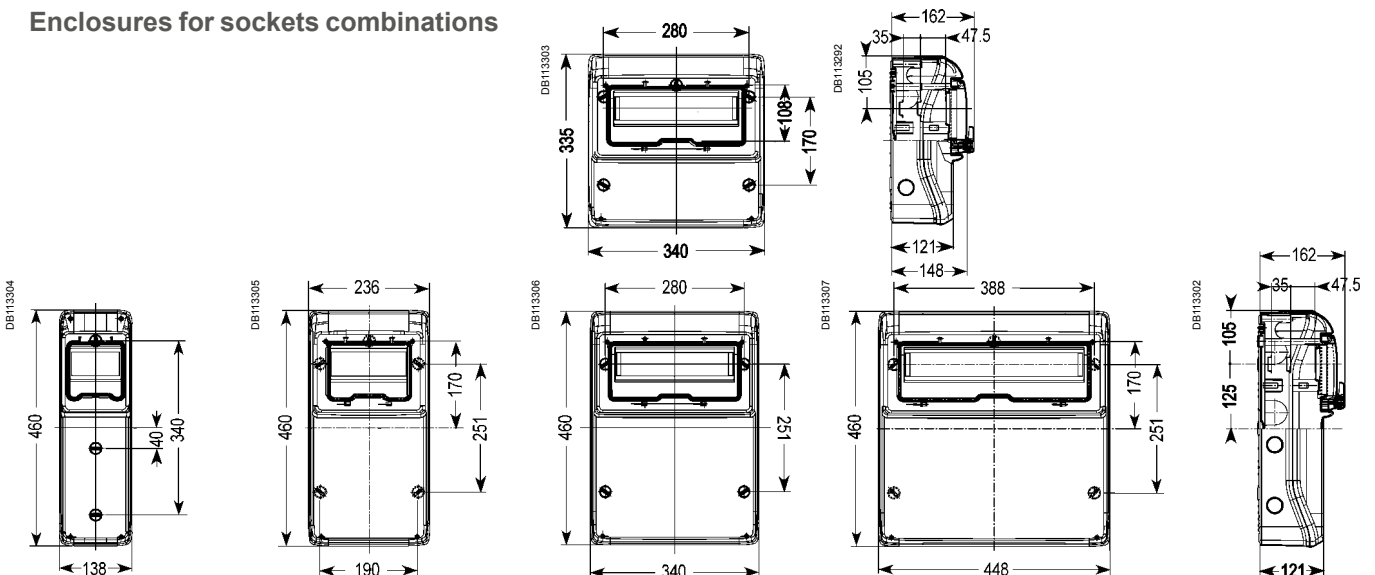

Kaedra System

Enclosures for modular devices

Mini enclosures for modular devices

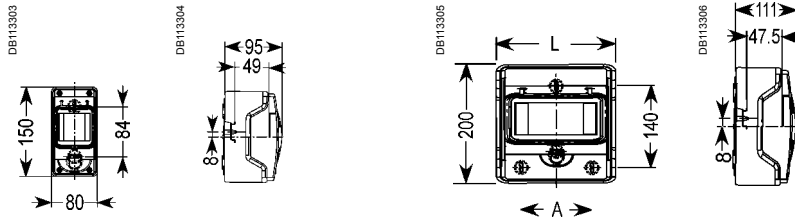

Modules	A	L
4	-	123
6	-	159
8	88	195
12	160	267

Enclosures for modular devices

With interface

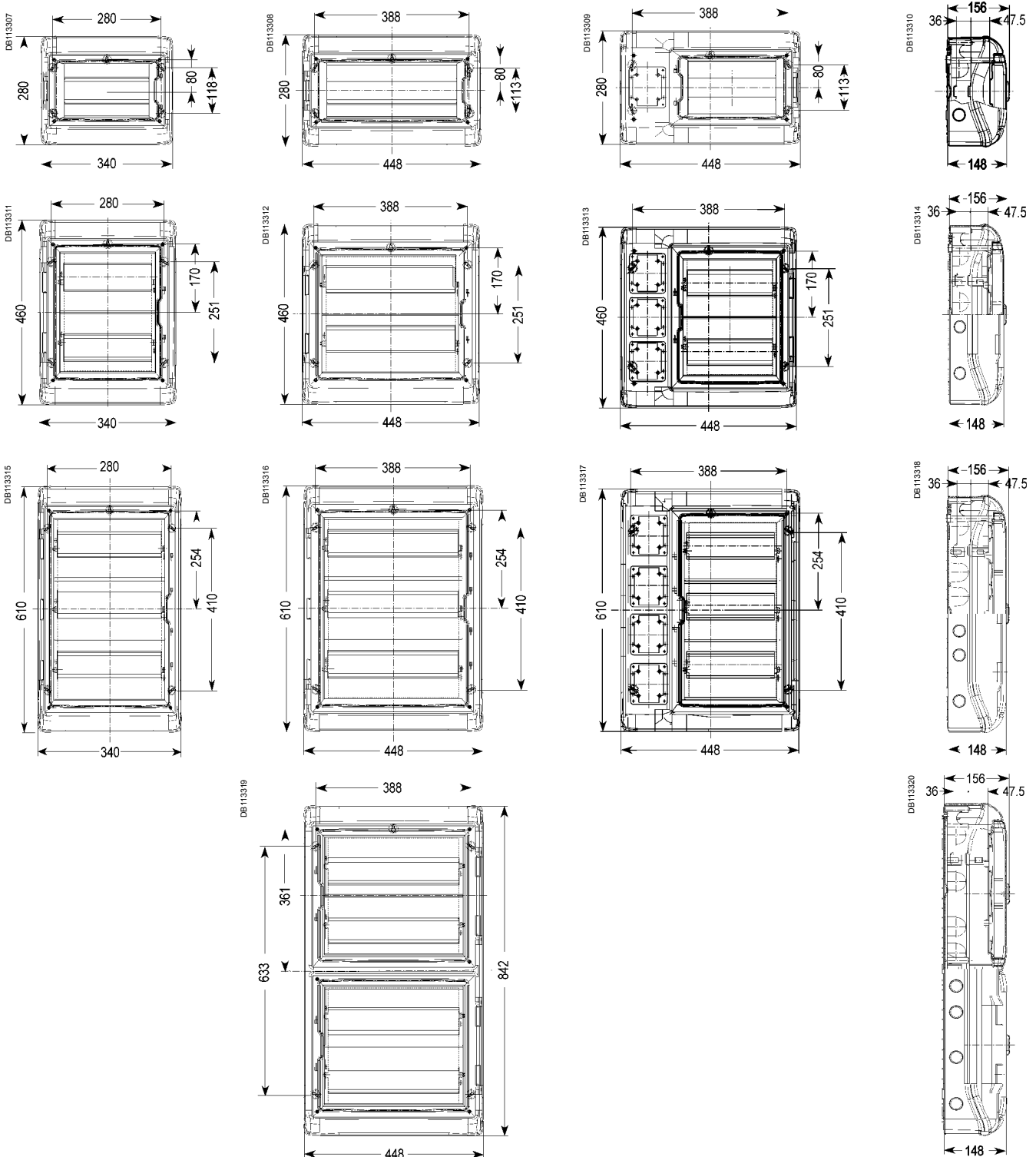

Kaedra System

Interface enclosures / Universal enclosures

Interface enclosures

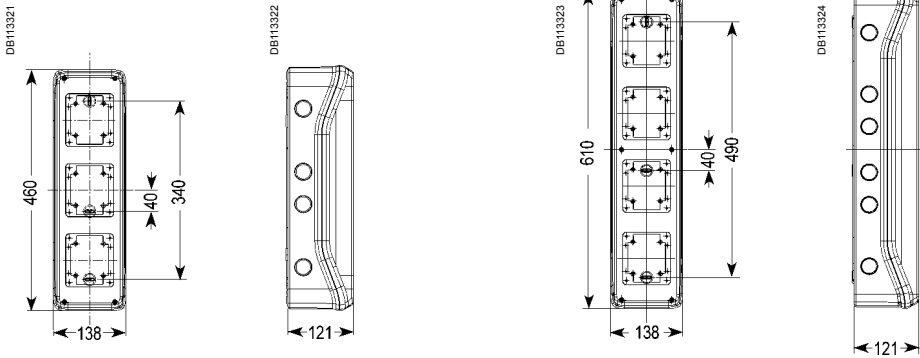

Universal enclosures

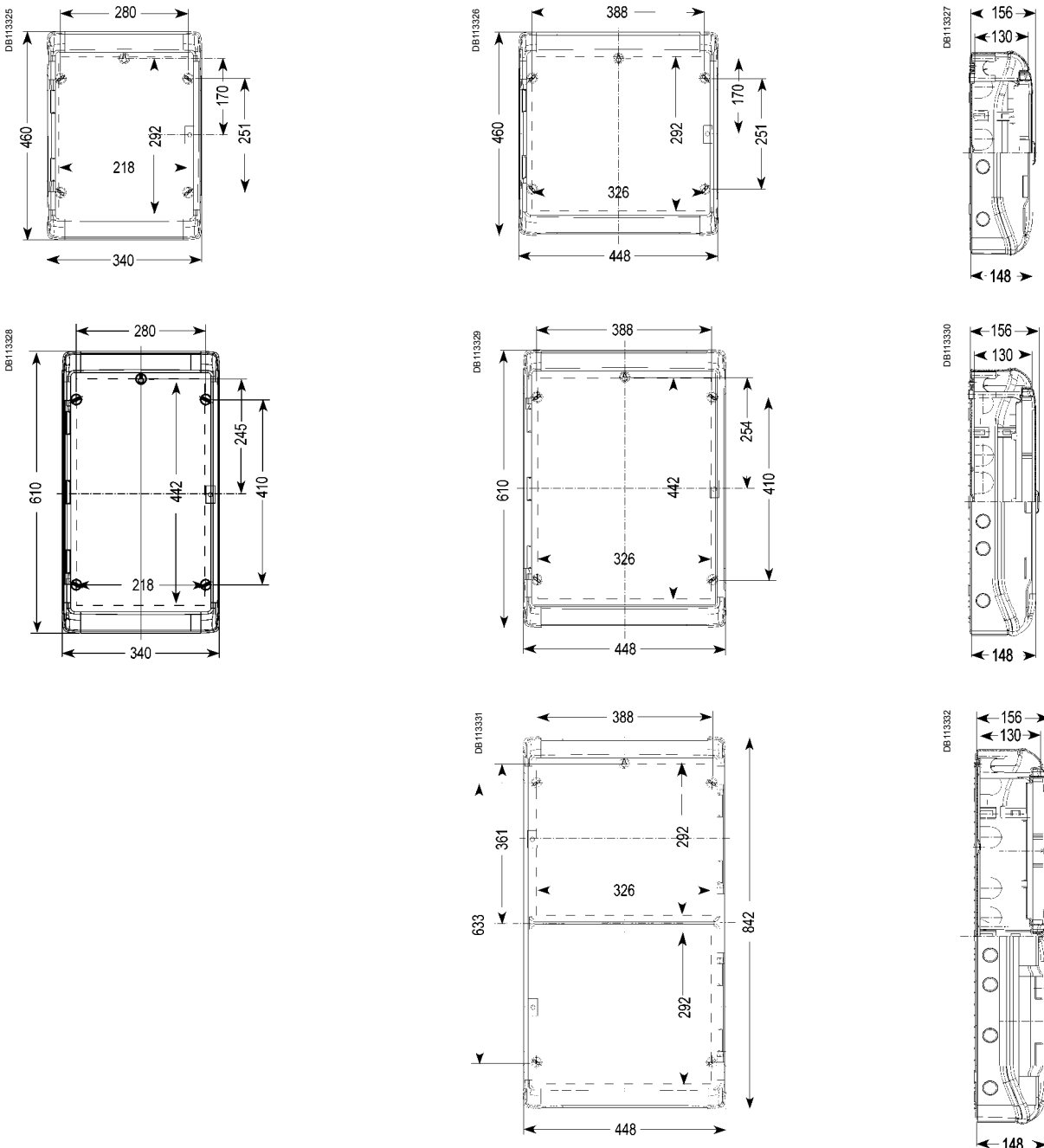

Code	Page	Code	Page	Code	Page	Code	Page	Code	Page	Code	Page
10200		13983	56	81392	14, 16	81716	15, 17	82026	37, 41	82117	37, 39
10200	60	13993	56	81394	14, 16	81720	15, 17	82027	37, 41	82118	37
10209	60	13994	56	81395	14, 16	81721	15, 17	82028	40, 42	82119	37, 39
10210	60			81397	14, 16	81726	15, 23	82029	40, 42	82120	37, 39
10220	60	81100		81398	14, 16	81728	15, 23	82030	40, 42	82125	37, 39
10500	60	81139	27, 35	81476	26, 28	81729	15, 23	82031	40, 42	82126	37, 39
10501	60	81140	27, 35	81477	26, 28	81732	15, 23	82032	40, 42	82127	37, 39
10502	60	81141	27, 35	81478	26, 28	81733	15, 23	82033	40, 42	82128	40, 42
		81142	27, 35	81479	26, 28	81754	15, 17	82034	40, 42	82129	40, 42
13100		81143	27, 35	81480	26, 28	81758	15, 17	82035	40, 42	82130	40, 42
13135	59	81144	27, 35	81482	26, 28	81759	15, 17	82036	40, 42	82131	42
13136	59	81145	27, 35	81483	26, 28	81766	15, 17	82037	40, 42	82132	40, 42
13137	59	81146	27, 35	81485	26, 28	81770	15, 17	82038	40, 42	82133	40, 42
13138	59	81176	26, 30	81486	26, 28	81771	15, 17	82039	40, 42	82134	40, 42
13139	59	81177	26, 30	81488	26, 28	81776	15, 23	82040	40, 42	82135	40, 42
13140	59	81178	26, 30	81489	26, 28	81777	15, 23	82041	40, 42	82136	40, 42
13141	59	81179	26, 30	81490	26, 28	81778	15, 23	82042	40, 42	82137	40, 42
13142	47, 59	81180	26, 30	81491	26, 28	81779	15, 23	82043	40, 42	82138	40, 42
13143	47, 59	81182	26, 30	81492	26, 28	81780	15, 23	82044	40, 42	82139	40, 42
13144	47, 59	81183	26, 30	81494	26, 28	81782	15, 23	82045	40, 42	82140	40, 42
13175	56, 57	81185	26, 30	81495	26, 28	81783	15, 23	82046	40, 42	82141	40, 42
13176	56, 57	81186	26, 30	81497	26, 28	81801	15, 20	82047	40, 42	82142	40, 42
13177	56, 57	81188	26, 30	81498	26, 28	81802	15, 20	82048	40, 42	82143	40, 42
13178	56, 57	81189	26, 30	81576	14, 19	81803	15, 20	82049	40, 42	82144	40, 42
13179	56, 57	81190	26, 30	81577	14, 19	81804	15, 20	82061	37, 41, 49	82145	40, 42
13180	56, 57	81191	26, 30	81578	14, 19	81805	15, 20	82062	37, 41, 49	82146	40, 42
13181	56, 57	81192	26, 30	81579	14, 19	81806	15, 20	82063	37, 41, 49	82147	40, 42
13182	56, 57	81194	26, 30	81580	14, 19	81807	15, 20	82064	37, 41, 49	82148	40, 42
13185	56, 57	81195	26, 30	81582	14, 19	81808	15, 20	82076	37, 41	82149	40, 42
13186	56, 57	81197	26, 30	81583	14, 19	81809	15, 20	82077	37, 41	82151	37, 39
13187	56, 57	81198	26, 30	81585	14, 19	81811	15, 20	82078	40, 42	82152	37, 39
13188	56, 57	81199	27, 53, 55	81586	14, 19	81812	15, 20	82079	40, 42	82153	37, 39
13189	56, 57	81276	26, 33	81588	14, 19	81813	15, 20	82080	40, 42	82154	37, 39
13190	56, 57	81277	26, 33	81589	14, 19	81814	15, 20	82081	40, 42	82155	37, 39
13191	56, 57	81278	26, 33	81590	14, 19	81815	15, 20	82082	40, 42	82156	37, 39
13192	56, 57	81279	26, 33	81591	14, 19	81816	15, 20	82083	40, 42	82161	37, 39
13193	56, 57	81280	26, 33	81592	14, 19	81817	15, 20	82084	40, 42	82162	37, 39
13361	60	81282	26, 33	81594	14, 19	81818	15, 20	82085	40, 42	82163	37, 39
13362	60	81283	26, 33	81595	14, 19	81819	15, 20	82086	40, 42	82165	37, 39
13363	60	81285	26, 33	81597	14, 19	81820	15, 20	82087	40, 42	82166	37, 39
13364	60	81286	26, 33	81598	14, 19	81821	15, 20	82088	40, 42	82167	37, 39
13575	60	81288	26, 33	81599	15, 52, 55	81823	15, 20	82089	40, 42	82168	37, 39
13576	60	81289	26, 33	81676	26, 33	81824	15, 20	82090	40, 42	82169	37, 39
13577	60	81290	26, 33	81677	26, 33	81876	14, 20	82091	40, 42	82170	37, 39
13578	60	81291	26, 33	81678	26, 33	81877	14, 20	82092	40, 42	82175	37, 39
13579	60	81292	26, 33	81679	26, 33	81878	14, 20	82093	40, 42	82176	37, 39
13581	60	81294	26, 33	81680	26, 33	81879	14, 20	82094	40, 42	82177	37, 39
13582	60	81295	26, 33	81682	26, 33	81880	14, 20	82095	40, 42	82178	40, 42
13583	60	81297	26, 33	81683	26, 33	81882	14, 20	82096	40, 42	82179	40, 42
13584	60	81298	26, 33	81685	26, 33	81883	14, 20	82097	40, 42	82180	40, 42
13585	60	81376	14, 16	81686	26, 33	81885	14, 20	82098	40, 42	82181	40, 42
13586	60	81377	14, 16	81688	26, 33	81886	14, 20	82099	40, 42	82182	40, 42
13587	60	81378	14, 16	81689	26, 33	81888	14, 20	82101	37, 39	82183	40, 42
13588	60	81379	14, 16	81690	26, 33	81889	14, 20	82102	37, 39	82184	40, 42
13589	60	81380	14, 16	81691	26, 33	81890	14, 20	82103	37, 39	82185	40, 42
13595	60	81382	14, 16	81692	26, 33	81891	14, 20	82104	37, 39	82186	40, 42
13597	60	81383	14, 16	81694	26, 33	81892	14, 20	82105	37, 39	82187	40, 42
13598	60	81385	14, 16	81695	26, 33	81894	14, 20	82106	37, 39	82188	40, 42
13599	60	81386	14, 16	81697	26, 33	81895	14, 20	82111	37, 39	82189	40, 42
13925	60	81388	14, 16	81698	26, 33	81897	14, 20	82112	37, 39	82190	40, 42
13934	47	81389	14, 16	81704	15, 17	81898	14, 20	82113	37, 39	82191	40, 42
13941	60	81390	14, 16	81708	15, 17			82115	37, 39	82192	40, 42
13946	60	81391	14, 16	81709	15, 17	82020		82116	37, 39	82193	40, 42

Code	Page	Code	Page	Code	Page	Code	Page	Code	Page	Code	Page
82194	40, 42	82445	51	82904	37, 39	83080	40, 43	83149	40, 43	83508	15, 19
82195	40, 42	82451	37, 38	82905	37, 39	83081	40, 43	83151	27, 30	83509	15, 19
82196	40, 42	82452	37, 38	82906	37, 39	83082	40, 43	83152	27, 30	83511	15, 19
82197	40, 42	82453	37, 38	82911	37, 39	83083	40, 43	83153	27, 30	83512	15, 19
82198	40, 42	82454	37, 38	82912	37, 39	83084	40, 43	83154	27, 30	83513	15, 19
82199	40, 42	82455	37, 38	82913	37, 39	83085	40, 43	83155	27, 30	83514	15, 19
82301	24, 25	82456	37, 38	82915	37, 39	83086	40, 43	83156	27, 30	83515	15, 19
82302	24, 25	82461	37, 38	82916	37, 39	83087	40, 43	83157	27, 30	83516	15, 19
82303	24, 25	82462	37, 38	82917	37, 39	83088	40, 43	83158	27, 30	83517	15, 19
82304	24, 25	82463	37, 38	82918	37	83089	40, 43	83159	27, 30	83518	15, 19
82305	24, 25	82465	37, 38	82919	37, 39	83090	40, 43	83161	27, 30	83519	15, 19
82306	24, 25	82466	37, 38	82920	37, 39	83091	40, 43	83162	27, 30	83520	15, 19
82311	24, 25	82467	37, 38	82925	37, 39	83092	40, 43	83163	27, 30	83521	15, 19
82312	24, 25	82468	37, 38	82926	37, 39	83093	40, 43	83164	27, 30	83523	15, 19
82313	24, 25	82469	37, 38	82927	37, 39	83094	40, 43	83165	27, 30	83524	15, 19
82315	24, 25	82470	37, 38	82951	37, 39	83095	40, 43	83166	27, 30	83526	15, 23
82316	24, 25	82475	37, 38	82952	37, 39	83096	40, 43	83167	27, 30	83527	15, 23
82317	24, 25	82476	37, 38	82953	37, 39	83097	40, 43	83168	27, 30	83528	15, 23
82318	24, 25	82477	37, 38	82954	37, 39	83098	40, 43	83169	27, 30	83529	15, 23
82319	24, 25	82479	51	82955	37, 39	83099	40, 43	83170	27, 30	83530	15, 23
82320	24, 25	82482	51	82956	37, 39	83101	27, 30	83171	27, 30	83531	15, 23
82325	24, 25	82483	51	82961	37, 39	83102	27, 30	83173	27, 30	83532	15, 23
82326	24, 25	82485	51	82962	37, 39	83103	27, 30	83174	27, 30	83533	15, 23
82327	24, 25	82491	51	82963	37, 39	83104	27, 30	83178	40, 43	83551	15, 19
82351	24, 25	82494	51	82965	37, 39	83105	27, 30	83179	40, 43	83552	15, 19
82352	24, 25	82495	51	82966	37, 39	83106	27, 30	83180	40, 43	83553	15, 19
82353	24, 25	82497	51	82967	37, 39	83107	27, 30	83181	40, 43	83554	15, 19
82354	24, 25	82501	24, 25	82968	37, 39	83108	27, 30	83182	40, 43	83555	15, 19
82355	24, 25	82502	24, 25	82969	37, 39	83109	27, 30	83183	40, 43	83556	15, 19
82356	24, 25	82503	24, 25	82970	37, 39	83111	27, 30	83184	40, 43	83557	15, 19
82361	24, 25	82504	24, 25	82975	37, 39	83112	27, 30	83185	40, 43	83558	15, 19
82362	24, 25	82505	24, 25	82976	37, 39	83113	27, 30	83186	40, 43	83559	15, 19
82363	24, 25	82506	24, 25	82977	37, 39	83114	27, 30	83187	40, 43	83561	15, 19
82365	24, 25	82511	24, 25			83115	27, 30	83188	40, 43	83562	15, 19
82366	24, 25	82512	24, 25	83020		83116	27, 30	83189	40, 43	83563	15, 19
82367	24, 25	82513	24, 25	83026	37, 41	83117	27, 30	83190	40, 43	83564	15, 19
82368	24, 25	82515	24, 25	83027	37, 41	83118	27, 30	83191	40, 43	83565	15, 19
82369	24, 25	82516	24, 25	83028	40, 43	83119	27, 30	83192	40, 43	83566	15, 19
82370	24, 25	82517	24, 25	83029	40, 43	83120	27, 30	83193	40, 43	83567	15, 19
82375	24, 25	82518	24, 25	83030	40, 43	83121	27, 30	83194	40, 43	83568	15, 19
82376	24, 25	82519	24, 25	83031	40, 43	83123	27, 30	83195	40, 43	83569	15, 19
82377	24, 25	82520	24, 25	83032	40, 43	83124	27, 30	83196	40, 43	83570	15, 19
82401	37, 38	82525	24, 25	83033	40, 43	83128	40, 43	83197	40, 43	83571	15, 19
82402	37, 38	82526	24, 25	83034	40, 43	83129	40, 43	83198	40, 43	83573	15, 19
82403	37, 38	82527	24, 25	83035	40, 43	83130	40, 43	83199	40, 43	83574	15, 19
82404	37, 38	82754	40, 49	83036	40, 43	83131	40, 43	83299	40, 53, 55	83576	15, 23
82405	37, 38	82758	40, 49	83037	40, 43	83132	40, 43	83325	41, 50	83577	15, 23
82406	37, 38	82759	40, 49	83038	40, 43	83133	40, 43	83326	41, 50	83578	15, 23
82411	37, 38	82764	40, 49	83039	40, 43	83134	40, 43	83327	41, 50	83579	15, 23
82412	37, 38	82766	40, 49	83040	40, 43	83135	40, 43	83399	40, 53, 55	83580	15, 23
82413	37, 38	82770	40, 49	83041	40, 43	83136	40, 43	83454	40, 48	83581	15, 23
82415	37, 38	82771	40, 49	83042	40, 43	83137	40, 43	83458	40, 48	83582	15, 23
82416	37, 38	82782	40, 49	83043	40, 43	83138	40, 43	83459	40, 48	83791	40, 49
82417	37, 38	82783	40, 49	83044	40, 43	83139	40, 43	83466	40, 48	83795	40, 49
82418	37	82786	40, 49	83045	40, 43	83140	40, 43	83470	40, 48	83796	40, 49
82419	37, 38	82879	40, 48	83046	40, 43	83141	40, 43	83471	40, 48	83799	40, 53, 55
82420	37, 38	82882	40, 48	83047	40, 43	83142	40, 43	83501	15, 19	83827	15, 23
82425	37, 38	82883	40, 48	83048	40, 43	83143	40, 43	83502	15, 19	83829	15, 23
82426	37, 38	82885	40, 48	83049	40, 43	83144	40, 43	83503	15, 19	83830	15, 23
82427	37, 38	82886	40, 48	83076	37, 41	83145	40, 43	83504	15, 19	83831	15, 23
82432	51	82901	37, 39	83077	37, 41	83146	40, 43	83505	15, 19	83832	15, 23
82433	51	82902	37, 39	83078	40, 43	83147	40, 43	83506	15, 19	83833	15, 23
82444	51	82903	37, 39	83079	40, 43	83148	40, 43	83507	15, 19	83851	15, 20

Code	Page	Code	Page	Code	Page	Code	Page	Code	Page	Code	Page
83852	15, 20	PKB002	41, 46	PKE16M445	15, 16	PKF16F424	27, 33	PKF16W414	27, 29	PKF32G734	27, 33
83853	15, 20	PKB63P514	40, 43	PKE16M713	15, 16	PKF16F425	27, 33	PKF16W415	27, 29	PKF32G735	27, 33
83854	15, 20	PKB63P515	40, 43	PKE16M714	15, 16	PKF16F433	27, 33	PKF16W423	27, 29	PKF32G744	27, 33
83855	15, 20	PKB63P523	40, 43	PKE16M715	15, 16	PKF16F434	27, 33	PKF16W424	27, 29	PKF32G745	27, 33
83856	15, 20	PKB63P524	40, 43	PKE16M723	15, 16	PKF16F435	27, 33	PKF16W425	27, 29	PKF32M7C4	27, 53, 55
83857	15, 20	PKB63P525	40, 43	PKE16M724	15, 16	PKF16F444	27, 33	PKF16W433	27, 29	PKF32M413	27, 28
83858	15, 20	PKB63P534	40, 43	PKE16M725	15, 16	PKF16F445	27, 33	PKF16W434	27, 29	PKF32M414	27, 28
83859	15, 20	PKB63P535	40, 43	PKE16M733	15, 16	PKF16F713	27, 33	PKF16W435	27, 29	PKF32M415	27, 28
83861	15, 20	PKB63P544	40, 43	PKE16M734	15, 16	PKF16F714	27, 33	PKF16W444	27, 29	PKF32M423	27, 28
83862	15, 20	PKB63P545	40, 43	PKE16M735	15, 16	PKF16F715	27, 33	PKF16W445	27, 29	PKF32M424	27, 28
83863	15, 20	PKB63Q514	40, 43	PKE16M744	15, 16	PKF16F723	27, 33	PKF16W713	27, 29	PKF32M425	27, 28
83864	15, 20	PKB63Q515	40, 43	PKE16M745	15, 16	PKF16F724	27, 33	PKF16W714	27, 29	PKF32M433	27, 28
83865	15, 20	PKB63Q523	40, 43	PKE16W413	15, 18	PKF16F725	27, 33	PKF16W715	27, 29	PKF32M434	27, 28
83866	15, 20	PKB63Q524	40, 43	PKE16W414	15, 18	PKF16F733	27, 33	PKF16W723	27, 29	PKF32M435	27, 28
83867	15, 20	PKB63Q525	40, 43	PKE16W415	15, 18	PKF16F734	27, 33	PKF16W724	27, 29	PKF32M444	27, 28
83868	15, 20	PKB63Q534	40, 43	PKE16W423	15, 18	PKF16F735	27, 33	PKF16W725	27, 29	PKF32M445	27, 28
83869	15, 20	PKB63Q535	40, 43	PKE16W424	15, 18	PKF16F744	27, 33	PKF16W733	27, 29	PKF32M713	27, 28
83870	15, 20	PKB63Q544	40, 43	PKE16W425	15, 18	PKF16F745	27, 33	PKF16W734	27, 29	PKF32M714	27, 28
83871	15, 20	PKB63Q545	40, 43	PKE16W433	15, 18	PKF16G413	27, 33	PKF16W735	27, 29	PKF32M715	27, 28
83873	15, 20	PKB63R514	40, 43	PKE16W434	15, 18	PKF16G414	27, 33	PKF16W744	27, 29	PKF32M723	27, 28
83874	15, 20	PKB63R515	40, 43	PKE16W435	15, 18	PKF16G415	27, 33	PKF16W745	27, 29	PKF32M724	27, 28
83876	15, 23	PKB63R523	40, 43	PKE16W444	15, 18	PKF16G423	27, 33	PKF32F7C4	27, 53, 55	PKF32M725	27, 28
83877	15, 23	PKB63R524	40, 43	PKE16W445	15, 18	PKF16G424	27, 33	PKF32F413	27, 33	PKF32M733	27, 28
83878	15, 23	PKB63R525	40, 43	PKE32M7C4	15, 52, 55	PKF16G425	27, 33	PKF32F414	27, 33	PKF32M734	27, 28
83879	15, 23	PKB63R534	40, 43	PKE32M413	15, 16	PKF16G433	27, 33	PKF32F415	27, 33	PKF32M735	27, 28
83880	15, 23	PKB63R535	40, 43	PKE32M414	15, 16	PKF16G434	27, 33	PKF32F423	27, 33	PKF32M744	27, 28
83881	15, 23	PKB63T514	40, 42	PKE32M415	15, 16	PKF16G435	27, 33	PKF32F424	27, 33	PKF32M745	27, 28
83882	15, 23	PKB63T515	40, 42	PKE32M423	15, 16	PKF16G444	27, 33	PKF32F425	27, 33	PKF32W7C4	27, 53, 55
83883	15, 23	PKB63T523	40, 42	PKE32M424	15, 16	PKF16G445	27, 33	PKF32F433	27, 33	PKF32W413	27, 29
83899	15, 52, 55	PKB63T524	40, 42	PKE32M425	15, 16	PKF16G713	27, 33	PKF32F434	27, 33	PKF32W414	27, 29
83901	15, 23	PKB63T525	40, 42	PKE32M433	15, 16	PKF16G714	27, 33	PKF32F435	27, 33	PKF32W415	27, 29
83902	15, 23	PKB63T534	40, 42	PKE32M434	15, 16	PKF16G715	27, 33	PKF32F444	27, 33	PKF32W423	27, 29
83903	15, 23	PKB63T535	40, 42	PKE32M435	15, 16	PKF16G723	27, 33	PKF32F445	27, 33	PKF32W424	27, 29
83905	15, 23	PKB63T544	40, 42	PKE32M444	15, 16	PKF16G724	27, 33	PKF32F713	27, 33	PKF32W425	27, 29
83906	15, 23	PKB63T545	40, 42	PKE32M445	15, 16	PKF16G725	27, 33	PKF32F714	27, 33	PKF32W433	27, 29
83911	15, 23	PKB63U514	40, 42	PKE32M713	15, 16	PKF16G733	27, 33	PKF32F715	27, 33	PKF32W434	27, 29
83912	15, 23	PKB63U515	40, 42	PKE32M714	15, 16	PKF16G734	27, 33	PKF32F723	27, 33	PKF32W435	27, 29
83913	15, 23	PKB63U523	40, 42	PKE32M715	15, 16	PKF16G735	27, 33	PKF32F724	27, 33	PKF32W444	27, 29
83914	15, 23	PKB63U524	40, 42	PKE32M723	15, 16	PKF16G744	27, 33	PKF32F725	27, 33	PKF32W445	27, 29
83915	15, 23	PKB63U525	40, 42	PKE32M724	15, 16	PKF16G745	27, 33	PKF32F733	27, 33	PKF32W713	27, 29
83919	41, 46	PKB63U534	40, 42	PKE32M725	15, 16	PKF16M413	27, 28	PKF32F734	27, 33	PKF32W714	27, 29
83920	41, 46	PKB63U535	40, 42	PKE32M733	15, 16	PKF16M414	27, 28	PKF32F735	27, 33	PKF32W715	27, 29
83921	41, 47	PKB63U544	40, 42	PKE32M734	15, 16	PKF16M415	27, 28	PKF32F744	27, 33	PKF32W723	27, 29
83922	41, 47	PKB63U545	40, 42	PKE32M735	15, 16	PKF16M423	27, 28	PKF32F745	27, 33	PKF32W724	27, 29
83923	41, 47	PKB63V514	40, 42	PKE32M744	15, 16	PKF16M424	27, 28	PKF32G7C4	27, 55	PKF32W725	27, 29
83924	41, 46	PKB63V515	40, 42	PKE32M745	15, 16	PKF16M425	27, 28	PKF32G413	27, 33	PKF32W733	27, 29
83925	41, 50	PKB63V523	40, 42	PKE32W413	15, 18	PKF16M433	27, 28	PKF32G414	27, 33	PKF32W734	27, 29
83926	41, 50	PKB63V524	40, 42	PKE32W414	15, 18	PKF16M434	27, 28	PKF32G415	27, 33	PKF32W735	27, 29
83927	41, 50	PKB63V525	42	PKE32W415	15, 18	PKF16M435	27, 28	PKF32G423	27, 33	PKF32W744	27, 29
83933	20	PKB63V534	40, 42	PKE32W423	15, 18	PKF16M444	27, 28	PKF32G424	27, 33	PKF32W745	27, 29
83934	23	PKB63V535	40, 42	PKE32W424	15, 18	PKF16M445	27, 28	PKF32G425	27, 33		
83935	20, 23			PKE32W425	15, 18	PKF16M713	27, 28	PKF32G433	27, 33	PKN	
83936	20, 55	PKE		PKE32W433	15, 18	PKF16M714	27, 28	PKF32G434	27, 33	PKN51B	27, 35
83937	20	PKE16M413	15, 16	PKE32W434	15, 18	PKF16M715	27, 28	PKF32G435	27, 33	PKN51G	27, 35
		PKE16M414	15, 16	PKE32W435	15, 18	PKF16M723	27, 28	PKF32G444	27, 33	PKN51N	27, 35
84100		PKE16M415	15, 16	PKE32W444	15, 18	PKF16M724	27, 28	PKF32G445	27, 33	PKN52B	27, 35
84118	39	PKE16M423	15, 16	PKE32W445	15, 18	PKF16M725	27, 28	PKF32G713	27, 33	PKN52G	27, 35
84518	38	PKE16M424	15, 16			PKF16M733	27, 28	PKF32G714	27, 33	PKN52N	27, 35
84918	39	PKE16M425	15, 16	PKF		PKF16M734	27, 28	PKF32G715	27, 33	PKN61B	27, 35
		PKE16M433	15, 16	PKF16F413	27, 33	PKF16M735	27, 28	PKF32G723	27, 33	PKN61G	27, 35
93900		PKE16M434	15, 16	PKF16F414	27, 33	PKF16M744	27, 28	PKF32G724	27, 33	PKN61N	27, 35
93934	20	PKE16M435	15, 16	PKF16F415	27, 33	PKF16M745	27, 28	PKF32G725	27, 33	PKN62B	27, 35
PKB		PKE16M444	15, 16	PKF16F423	27, 33	PKF16W413	27, 29	PKF32G733	27, 33	PKN62G	27, 35

Code	Page	Code	Page	Code	Page	Code	Page	Code	Page	Code	Page
PKN62N	27, 35	PKX32M715	15, 16	PKY16G735	27, 32	PKY32G423	27, 32	PKZM403	34		
PKS		PKX32M723	15, 16	PKY16G744	27, 32	PKY32G424	27, 32	PKZM406	34		
		PKX32M724	15, 16	PKY16G745	27, 32	PKY32G425	27, 32	PKZM409	34		
	PKS51B	27, 35	PKX32M725	15, 16	PKY16M413	27, 28	PKY32G433	27, 32	PKZM412	34	
	PKS51G	27, 35	PKX32M733	15, 16	PKY16M414	27, 28	PKY32G434	27, 32	PKZM413	34	
	PKS51N	27, 35	PKX32M734	15, 16	PKY16M415	27, 28	PKY32G435	27, 32	PKZM701	34	
	PKS52B	27, 35	PKX32M735	15, 16	PKY16M423	27, 28	PKY32G444	27, 32	PKZM703	34	
	PKS52G	27, 35	PKX32M744	15, 16	PKY16M424	27, 28	PKY32G445	27, 32	PKZM705	34	
	PKS52N	27, 35	PKX32M745	15, 16	PKY16M425	27, 28	PKY32G713	27, 32	PKZM706	34	
	PKS61B	27, 35	PKX32W413	15, 18	PKY16M433	27, 28	PKY32G714	27, 32	PKZM707	34	
	PKS61G	27, 35	PKX32W414	15, 18	PKY16M434	27, 28	PKY32G715	27, 32	PKZM709	34	
	PKS61N	27, 35	PKX32W415	15, 18	PKY16M435	27, 28	PKY32G723	27, 32	PKZM712	34	
	PKS62B	27, 35	PKX32W423	15, 18	PKY16M444	27, 28	PKY32G724	27, 32	PKZM713	34	
	PKS62G	27, 35	PKX32W424	15, 18	PKY16M445	27, 28	PKY32G725	27, 32			
	PKS62N	27, 35	PKX32W425	15, 18	PKY16M713	27, 28	PKY32G733	27, 32			
PKX		PKX32W433	15, 18	PKY16M714	27, 28	PKY32G734	27, 32				
		PKX32W434	15, 18	PKY16M715	27, 28	PKY32G735	27, 32				
	PKX16M413	15, 16	PKX32W435	15, 18	PKY16M723	27, 28	PKY32G744	27, 32			
	PKX16M414	15, 16	PKX32W444	15, 18	PKY16M724	27, 28	PKY32G745	27, 32			
	PKX16M415	15, 16	PKX32W445	15, 18	PKY16M725	27, 28	PKY32M7C4	27, 53, 55			
	PKX16M423	15, 16	PKY		PKY16M733	27, 28	PKY32M413	27, 28			
	PKX16M424	15, 16		PKY16F413	27, 32	PKY16M734	27, 28	PKY32M414	27, 28		
	PKX16M425	15, 16		PKY16F414	27, 32	PKY16M735	27, 28	PKY32M415	27, 28		
	PKX16M433	15, 16		PKY16F415	27, 32	PKY16M744	27, 28	PKY32M423	27, 28		
	PKX16M434	15, 16		PKY16F423	27, 32	PKY16M745	27, 28	PKY32M424	27, 28		
	PKX16M435	15, 16		PKY16F424	27, 32	PKY16W413	27, 29	PKY32M425	27, 28		
	PKX16M444	15, 16		PKY16F425	27, 32	PKY16W414	27, 29	PKY32M433	27, 28		
	PKX16M445	15, 16		PKY16F433	27, 32	PKY16W415	27, 29	PKY32M434	27, 28		
	PKX16M713	15, 16		PKY16F434	27, 32	PKY16W423	27, 29	PKY32M435	27, 28		
PKX16M714	15, 16	PKY16F435		27, 32	PKY16W424	27, 29	PKY32M444	27, 28			
PKX16M715	15, 16	PKY16F444		27, 32	PKY16W425	27, 29	PKY32M445	27, 28			
PKX16M723	15, 16	PKY16F445		27, 32	PKY16W433	27, 29	PKY32M713	27, 28			
PKX16M724	15, 16	PKY16F445		27, 32	PKY16W434	27, 29	PKY32M714	27, 28			
PKX16M725	15, 16	PKY16F713		27, 32	PKY16W435	27, 29	PKY32M715	27, 28			
PKX16M733	15, 16	PKY16F714	27, 32	PKY16W444	27, 29	PKY32M723	27, 28				
PKX16M734	15, 16	PKY16F715	27, 32	PKY16W445	27, 29	PKY32M724	27, 28				
PKX16M735	15, 16	PKY16F723	27, 32	PKY32F7C4	27, 53, 55	PKY32M725	27, 28				
PKX16M744	15, 16	PKY16F724	27, 32	PKY32F413	27, 32	PKY32M733	27, 28				
PKX16M745	15, 16	PKY16F725	27, 32	PKY32F414	27, 32	PKY32M734	27, 28				
PKX16W413	15, 18	PKY16F733	27, 32	PKY32F415	27, 32	PKY32M735	27, 28				
PKX16W414	15, 18	PKY16F734	27, 32	PKY32F423	27, 32	PKY32M744	27, 28				
PKX16W415	15, 18	PKY16F735	27, 32	PKY32F424	27, 32	PKY32M745	27, 28				
PKX16W423	15, 18	PKY16F744	27, 32	PKY32F425	27, 32	PKY32M745	27, 28				
PKX16W424	15, 18	PKY16F745	27, 32	PKY32F433	27, 32	PKY32W413	27, 29				
PKX16W425	15, 18	PKY16G413	27, 32	PKY32F434	27, 32	PKY32W414	27, 29				
PKX16W433	15, 18	PKY16G414	27, 32	PKY32F435	27, 32	PKY32W415	27, 29				
PKX16W434	15, 18	PKY16G415	27, 32	PKY32F444	27, 32	PKY32W423	27, 29				
PKX16W435	15, 18	PKY16G423	27, 32	PKY32F445	27, 32	PKY32W424	27, 29				
PKX16W444	15, 18	PKY16G424	27, 32	PKY32F713	27, 32	PKY32W425	27, 29				
PKX16W445	15, 18	PKY16G425	27, 32	PKY32F714	27, 32	PKY32W433	27, 29				
PKX32M7C4	15, 52, 55	PKY16G433	27, 32	PKY32F715	27, 32	PKY32W434	27, 29				
PKX32M413	15, 16	PKY16G434	27, 32	PKY32F723	27, 32	PKY32W435	27, 29				
PKX32M414	15, 16	PKY16G435	27, 32	PKY32F724	27, 32	PKY32W444	27, 29				
PKX32M415	15, 16	PKY16G444	27, 32	PKY32F725	27, 32	PKY32W445	27, 29				
PKX32M423	15, 16	PKY16G445	27, 32	PKY32F733	27, 32	PKZ					
PKX32M424	15, 16	PKY16G713	27, 32	PKY32F734	27, 32		PKZ025	31			
PKX32M425	15, 16	PKY16G714	27, 32	PKY32F735	27, 32		PKZ032	31			
PKX32M433	15, 16	PKY16G715	27, 32	PKY32F744	27, 32		PKZ085	31			
PKX32M434	15, 16	PKY16G723	27, 32	PKY32F745	27, 32		PKZ100	31			
PKX32M435	15, 16	PKY16G724	27, 32	PKY32G7C4	27, 53, 55		PKZA201	21			
PKX32M444	15, 16	PKY16G725	27, 32	PKY32G413	27, 32		PKZA202	21			
PKX32M445	15, 16	PKY16G733	27, 32	PKY32G414	27, 32		PKZA203	21			
PKX32M713	15, 16	PKY16G734	27, 32	PKY32G415	27, 32		PKZA204	21			
PKX32M714	15, 16										



<https://sid1.hu/>

35, rue Joseph Monier
CS 30323
92506 Rueil Malmaison Cedex
France

RCS Nanterre 954 503 439
Capital social 896 313 776 €
www.schneider-electric.com

04/2018
FLVED208001EN

© 2018 - Schneider Electric. All Rights Reserved.
All trademarks are owned by Schneider Electric Industries SAS or its affiliated companies.

This document has been
printed on recycled paper

